

# Network Camera

## User Manual

imagine the possibilities

Thanks you for purchasing this Samsung product.  
To receive a more complete service, please visit  
our website  
[www.samsungsecurity.com](http://www.samsungsecurity.com)



RoHS compliant

Our product complies with "The Restriction Of the use of certain Hazardous Substances in electrical and electronic equipment", and we do not use the 6 hazardous materials- Cadmium (Cd), Lead (Pb), Mercury (Hg), Hexavalent Chromium (Cr<sup>6+</sup>), Poly Brominated Biphenyls (PBBs), Poly Brominated Diphenyl Ethers (PBDEs)- in our products.





## CAUTION

RISK OF ELECTRIC SHOCK.  
DO NOT OPEN



**CAUTION:** TO REDUCE THE RISK OF ELECTRIC SHOCK, DO NOT REMOVE COVER (OR BACK) NO USER SERVICEABLE PARTS INSIDE. REFER SERVICING TO QUALIFIED SERVICE PERSONNEL.



This symbol indicates that dangerous voltage consisting a risk of electric shock is present within this unit.



This symbol indicates that there are important operating and maintenance instructions in the literature accompanying this unit.

## WARNING

- To reduce the risk of fire or electric shock, do not expose this appliance to rain or moisture.
- To prevent injury, this apparatus must be securely attached to the floor/wall in accordance with the installation instructions.
- If this power supply is used at 24V ac, a suitable plug adapter should be used.
- The camera is to be only connected to PoE networks without routing to the outside plant.

## WARNING

1. Be sure to use only the standard adapter that is specified in the specification sheet. Using any other adapter could cause fire, electrical shock, or damage to the product.
2. Incorrectly connecting the power supply or replacing battery may cause explosion, fire, electric shock, or damage to the product.
3. Do not connect multiple cameras to a single adapter. Exceeding the capacity may cause abnormal heat generation or fire.
4. Securely plug the power cord into the power receptacle. Insecure connection may cause fire.
5. When installing the camera, fasten it securely and firmly. The fall of camera may cause personal injury.
6. Do not place conductive objects (e.g. screwdrivers, coins, metal parts, etc.) or containers filled with water on top of the camera. Doing so may cause personal injury due to fire, electric shock, or falling objects.

7. Do not install the unit in humid, dusty, or sooty locations. Doing so may cause fire or electric shock.
8. If any unusual smells or smoke come from the unit, stop using the product. In such case, immediately disconnect the power source and contact the service center. Continued use in such a condition may cause fire or electric shock.
9. If this product fails to operate normally, contact the nearest service center. Never disassemble or modify this product in any way. (SAMSUNG is not liable for problems caused by unauthorized modifications or attempted repair.)
10. When cleaning, do not spray water directly onto parts of the product. Doing so may cause fire or electric shock
11. Do not expose the product to the direct airflow from an air conditioner. Otherwise, it may cause moisture condensation inside the Clear Dome due to temperature difference between internal and external of the dome camera.
12. If you install this product in a low-temp area such as inside a cold store, you must seal up the wiring pipe with silicon, so that the external air can not flow inside the housing. Otherwise, external high, humid air may flow inside the housing, pooling moisture or vapor inside the product due to a difference between internal and external temperature.

## CAUTION

1. Do not drop objects on the product or apply strong blows to it. Keep away from a location subject to excessive vibration or magnetic interference.
2. Do not install in a location subject to high temperature (over 50°C), low temperature (below -10°C), or high humidity. Doing so may cause fire or electric shock.
3. If you want to relocate the already installed product, be sure to turn off the power and then move or reinstall it.
4. Remove the power plug from the outlet when there is a lightning storm. Neglecting to do so may cause fire or damage to the product.
5. Keep out of direct sunlight and heat radiation sources. It may cause fire.
6. Install it in a place with good ventilation.
7. Avoid aiming the camera directly towards extremely bright objects such as sun, as this may damage the CCD image sensor.
8. Apparatus shall not be exposed to dripping or splashing and no objects filled with liquids, such as vases, shall be placed on the apparatus.
9. The Mains plug is used as a disconnect device and shall stay readily operable at any time.
10. When using the camera outdoors, moisture may occur inside the camera due to temperature difference between indoors and outdoors. For this reason, it is recommended to install the camera indoors. For outdoor use, use the camera with built-in fan and heater.

## FCC STATEMENT

This device complies with part 15 of the FCC Rules. Operation is subject to the following two conditions :

- 1) This device may not cause harmful interference, and
- 2) This device must accept any interference received including interference that may cause undesired operation.

### Caution

This equipment has been tested and found to comply with the limits for a Class A digital device, pursuant to part 15 of FCC Rules. These limits are designed to provide reasonable protection against harmful interference when the equipment is operated in a commercial environment.

This equipment generates, uses, and can radiate radio frequency energy and, if not installed and used in accordance with the instruction manual, may cause harmful interference to radio communications. Operation of this equipment in a residential area is likely to cause harmful interference in which case the user will be required to correct the interference at his own expense.



### IC Compliance Notice

This Class A digital apparatus meets all requirements of the Canadian Interference.-Causing Equipment Regulations of ICES-003.

## IMPORTANT SAFETY INSTRUCTIONS

---

1. Read these instructions.
2. Keep these instructions.
3. Heed all warnings.
4. Follow all instructions.
5. Do not use this apparatus near water.
6. Clean only with dry cloth.
7. Do not block any ventilation openings. Install in accordance with the manufacturer's instructions.
8. Do not install near any heat sources such as radiators, heat registers, or other apparatus (including amplifiers) that produce heat.
9. Do not defeat the safety purpose of the polarized or grounding-type plug. A polarized plug has two blades with one wider than the other. A grounding type plug has two blades and a third grounding prong. The wide blade or the third prong is provided for your safety. If the provided plug does not fit into your outlet, consult an electrician for replacement of the obsolete outlet.
10. Protect the power cord from being walked on or pinched particularly at plugs, convenience receptacles, and the point where they exit from the apparatus.
11. Only use attachments/accessories specified by the manufacturer.
12. Use only with the cart, stand, tripod, bracket, or table specified by the manufacturer, or sold with the apparatus. When a cart is used, use caution when moving the cart/apparatus combination to avoid injury from tip-over.
13. Unplug this apparatus during lightning storms or when unused for long periods of time.
14. Refer all servicing to qualified service personnel. Servicing is required when the apparatus has been damaged in any way, such as powersupply cord or plug is damaged, liquid has been spilled or objects have fallen into the apparatus, the apparatus has been exposed to rain or moisture, does not operate normally, or has been dropped.



Apparatus shall not be exposed to dripping or splashing and no objects filled with liquids, such as vases, shall be placed on the apparatus

<b>OVERVIEW</b>	6	Important Safety Instructions
	9	Product Features
2	9	Recommended PC Specifications
	10	What's Included
	11	At a Glance
<b>INSTALLATION &amp; CONNECTION</b>	14	Disassembling
	15	Inserting/Removing an SD Memory Card
14	16	Memory Card Information (not included)
	17	Connecting with other Device
	21	Installation
	21	Optional Accessories for Installation
<b>CAMERA SETUP</b>	27	How to use the menu key
	28	Main Menu
27	28	Profile
	29	Camera Setup
	33	Privacy Zone
	34	Others
	35	System Info
	35	Language
<b>NETWORK CONNECTION AND SETUP</b>	36	Connecting the Camera to an IP Router with the xDSL/Cable Modem
	37	Connecting the Camera to an IP Router with Local Area Networking
36	38	Connecting the Camera Directly to a DHCP-Based xDSL/Cable Modem
	39	Connecting the Camera Directly to Local Area Networking
	40	IP Address Setup
	41	Static IP Setup
	44	Dynamic IP Setup
	45	Port Range Forward (Port Mapping) Setup
	46	Connecting to the camera from a shared local PC
	46	Connecting to the camera from a remote PC via the Internet

## WEB VIEWER

47

- 47 Connecting to the camera
- 48 Login
- 49 Installing ActiveX
- 50 Using the Live Screen
- 51 Backup
- 54 Using the SD Search Viewer Screen

## SETUP SCREEN

55

- 55 Accessing the Setup screen
- 55 Default Setup
- 60 System Setup
- 64 Overlay Setup
- 65 Event Setup
- 72 Network Setup

## APPENDIX

73

- 73 Profile
- 74 Terminology
- 76 Specifications
- 80 Frame Rate (NTSC)
- 86 Frame Rate (PAL)
- 92 Troubleshooting



## PRODUCT FEATURES

---

- **Support various communication protocols**

Supports TCP/IP, UDP, RTP/RTSP, SMTP for email, and FTP protocols as well as various internet protocols such as ARP, HTTP, HTTPS and DHCP.

- **Web Browser-based Monitoring**

Using the Internet web browser to display the image in a local network environment.

- **Automatic Local IP Setup**

Even a network novice can install it with minimum operations.

- **Alarm**

If an alarm sensor is connected and it detects a motion, a message is sent to the registered address via FTP/email (SMTP) or stored in the SD memory card, or an alarm will signal to the alarm out terminal.

- **Intelligent Video Analysis**

If an event rule is defined for the video analysis and it detects a motion in the configured rule area, a message is sent to the registered address via FTP/email (SMTP) or stored in the SD memory card, or an alarm will signal to the alarm out terminal.

## PRECAUTIONS – INSTALLATION AND USE

---

- Do not bend or drop the SD memory card.
- Do not store or use the SD memory card in a high temperature, high humidity or dusty place.
- Be careful not to apply foreign substances on the terminals of SD memory card.
- In case of cleaning terminals, wipe gently with a soft cloth.
- Before ejecting the SD memory card, release the checkbox <SD Card Record> in <Alarm image> and press [Apply] button. (page 67)
- If SD memory card have reached its lifespan, no data will be saved. In this case, purchase a new one and replace the SD memory card.

## RECOMMENDED PC SPECIFICATIONS

---

- |   |   |
|---|---|
| • CPU : Pentium4 / 2.4GHz or higher   | • Web Browser : Internet Explorer 6.0 or higher |
| • Operating System : Windows XP(Service Pack2, Service Pack3) / Windows Vista | • Video Card : Radeon, Nvidia                   |
| • Resolution : 1024X768 pixels or higher                                      | • Video Memory: 128MB                           |
| • RAM : 512MB or higher   | • DirectX 8.1 or higher                         |

### Compatible IP Routers









- Linksys / D-Link / Netgear

### Compatible PoE Switches

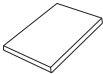
- Linksys SRW224G4P / D-Link DES-1316 / SMC SMCPWR-INJ3

## WHAT'S INCLUDED

Please check if your camera and accessories are all included in the product package.

Image	Part name	Standard	Quantity	Usage
	Camera	SNC-B5399	1	
	CD	User Manual/ IP INSTALLER S/W	1	
	User Manual		1	
	Cable for test monitor connection		1	Used to connect to a monitor for camera operation test. For connecting to a surveillance monitor, use BNC cable.
	Plastic Anchor	HUD 5	4	Used to fix the screws, for installation Insert the anchor into a drilled hole (to reinforce the strength).
	Fixing Screws	BH, M4 x L8, SILVER	4	Used when installing the case on the ceiling, with pipe or wall mount. Used to stop up a hole.
	Tapping Screws	TH, M4xL30. BLACK +O RING	4	Used for ceiling and wall installations
	L-wrench	TORX T-20	1	Used for assembling / disassembling the dome cover.
	Template	ART PAPER	1	Guiding template for the installation

## AT A GLANCE

### Appearance

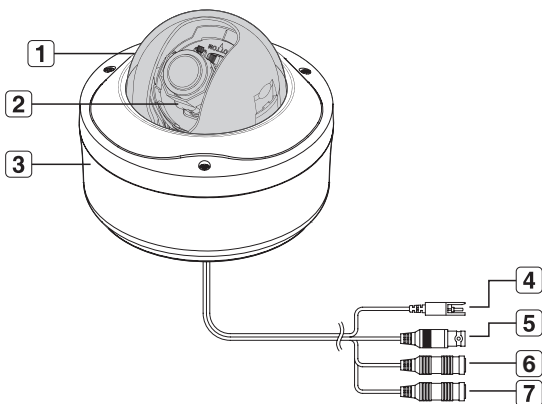

Item	Description
<b>1</b> Dome Cover	Dome cover for the lens and unit protection.
<b>2</b> Heater	Operates if ambient temperature drops below 5°C, for defrosting the dome cover.
<b>3</b> Main unit	Main unit includes the lens, switch board, PCB boards and screws.
<b>4</b> Power Port	Used to plug the power cable.
<b>5</b> Video Out Jack	Connects to the video input terminal of a monitor, which outputs the video signal from the camera.
<b>6</b> Audio In Jack	Used to connect to a microphone.
<b>7</b> Audio Out Jack	Used to connect to speakers.



- Wipe out a dirty surface of the lens softly with a lens tissue or cloth to which you have applied ethanol.
- Do not touch the unit since it is hot when the heater is operating.

## Inside

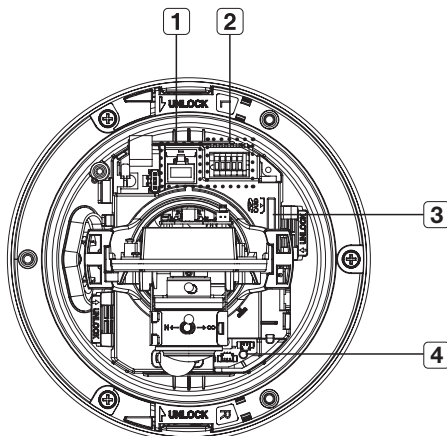

Item	Description
<b>1</b> Network Port	Used to connect a PoE or LAN cable.
<b>2</b> Alarm In / Out terminals	Alarm in/out terminals can be configured as follows: - <b>ALARM IN</b> : Terminal for Alarm Input. - <b>ALARM OUT</b> : Terminal for Alarm Output. - <b>GND</b> : Grounding terminal.
<b>3</b> SD Memory Card Compartment	Compartment for the SD memory card.
<b>4</b> Reset Button	Resets the camera settings. Press the button for about 3 seconds, and the system indicator turns off and will restart. <b>!</b> Resetting the camera requires reconfiguration of network settings (IP address, subnet mask, gateway address etc.) using the IP Installer software application.

## Components

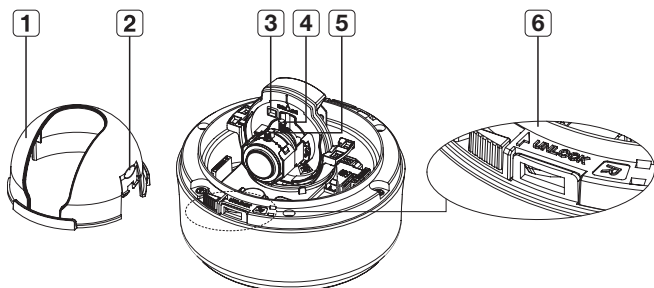

Item	Description
<b>1</b> Inner Cover	Cover for the main unit's protection.
<b>2</b> Side wing hooks	By lifting it while gently pressing the both ends, you can separate the inner cover.
<b>3</b> Monitor Out	Using the test monitor cable, you can connect to a mobile display for camera test.
<b>4</b> ZOOM lever	You can adjust or fix the zoom ratio
<b>5</b> Focus lever	Turn the barrel left or right to adjust the focus, and turn the knob clockwise to lock the focus.
<b>6</b> Lock Release	To separate the bracket from the main unit for the installation or to separate the camera from an installed camera, push this release and turn the main unit in the marked direction of <UNLOCK>.

# installation & connection

---

## DISASSEMBLING

---

To connect the alarm in/out, the dome cover and lens cover are to be separated.

1. Using the L-wrench provided, loosen 3 screws by turning them counterclockwise and separate the dome cover.

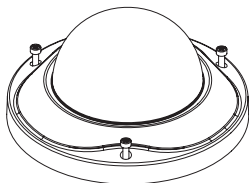

2. Lift up the inner cover while gently pressing its both ends to separate it from the unit.

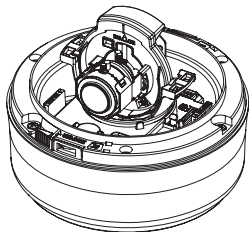

## INSERTING/REMOVING AN SD MEMORY CARD

### Inserting an SD Memory Card

Push the SD memory card in the direction of the arrow shown in the diagram.

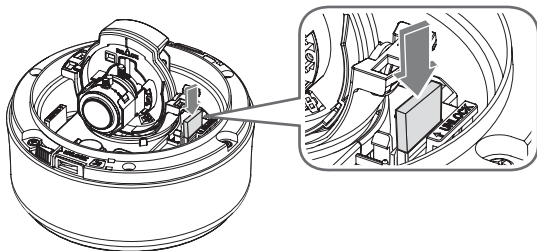

- ! Do not insert the SD memory card while it's upside down by force. Otherwise, it may damage the SD memory card.

### Removing an SD Memory Card

Gently press down on the exposed end of the memory card as shown in the diagram to eject the memory card from the slot.

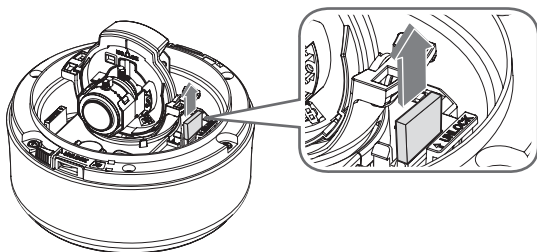

- ! Pressing too hard on the SD memory card can cause the card to shoot out uncontrollably from the slot when released.
- Before ejecting the SD memory card, release the checkbox **<SD Card Record>** in **<Alarm image>** and press **[Apply]** button. (page 67)

## MEMORY CARD INFORMATION (NOT INCLUDED)

---

### What is a memory card?

The memory card is an external data storage device that has been developed to offer an entirely new way to record and share video, audio, and text data using digital devices.

### Selecting a memory card that's suitable for you

Your camera supports SDHC memory cards.

You may, however, experience compatibility issues depending on the model and make of the memory card.

Your camera supports SD memory cards.

Note that supported memory card capacity is up to 2GB.

For your camera, we recommend you use a memory card from the following manufacturers: SDHC/SD Memory Card: Panasonic, Sandisk, Toshiba

Your camera supports 128MB to 16GB (SD Card : 2GB) of memory card capacity.

Playback performance can be affected depending on the speed of memory card, so use the high-speed memory card.

To ensure proper recording of video data, we recommend you use a memory card that supports at least read/write speed 10Mbps and Class 6.

### Memory Card Use

SD and SDHC memory cards feature a switch that disables writing data on to the media. Having this switch to the Lock position will prevent accidental deletion of data stored in the memory card but at the same time will also prevent you from writing data on to the media.

### ❖ Memory Card Components

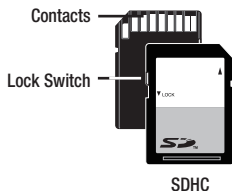



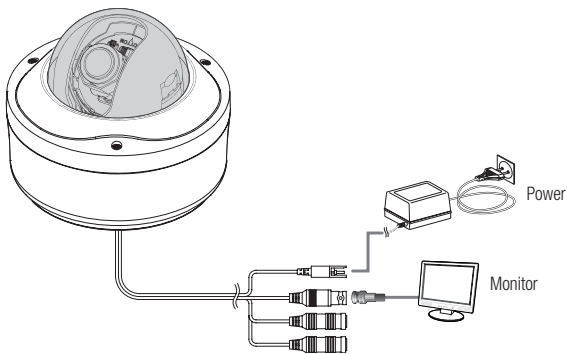

### Power Supply

Connect the power adaptor and camera's power in jack.

- ! Be careful not to reverse the polarity when you connect the power cable.  
You can also use a router featuring PoE (Power over Ethernet) to supply power to the camera.

### Connecting to the monitor

Connect the camera's Video Out jack and the monitor's video in jack.

# installation & connection

---

## Connecting to Audio Input/Output

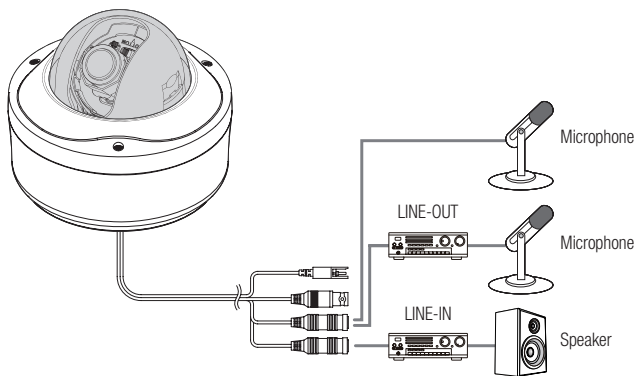

1. Connect the AUDIO IN port of the camera with the microphone directly or LINE OUT port of the amplifier that the microphone is connected to.
  - **Direct Mic Connection** : Set Audio Input Gain high (10). (Refer to page 56)
  - **Line Out Connection** : Set Audio Input Gain low (1). (Refer to page 56)
2. Connect the AUDIO OUT port of the camera with the LINE IN port of the speaker.

## Audio I/O Block Diagram

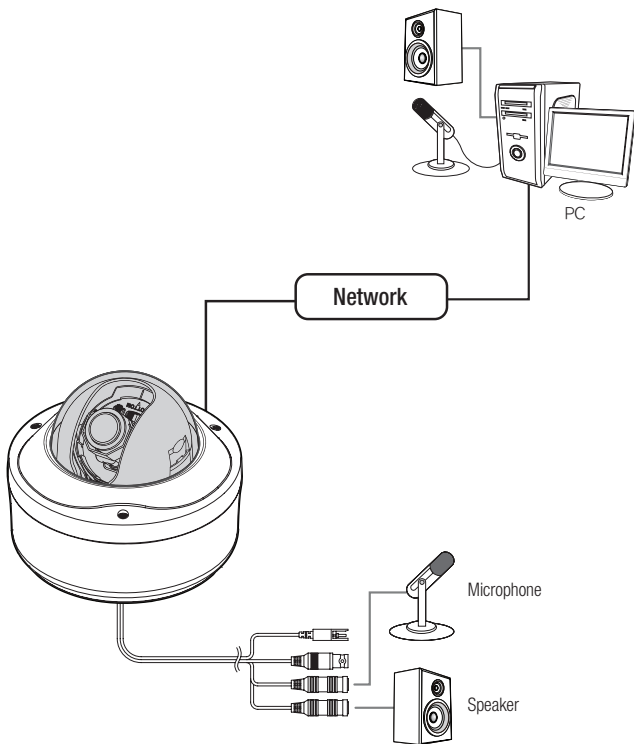

- **Audio Codec**  
G.711 PCM.  $\mu$ -law 64kbps 8kHz sampling
- **Full duplex Audio**
- **Audio in**  
Used for mono signal line input (Max.2.4 Vpp)
- **Audio out**  
Used for mono signal line output (Max.2.4 Vpp)
- **Line out impedance**  
600 $\Omega$

# installation & connection

## Connecting to the I/O port box

Connect the Alarm I/O cable to the corresponding port of the inner port box.

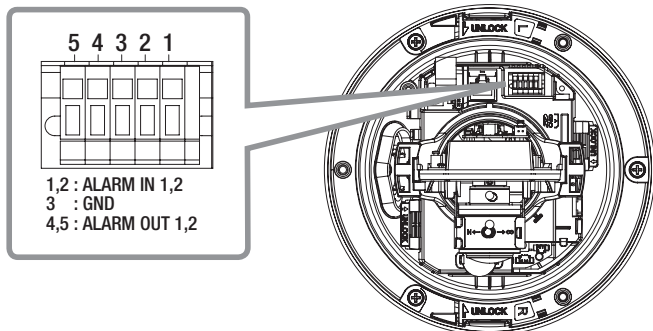

- ALARM IN 1, 2 : Used to connect the alarm input signal.
- GND : Used for earth-grounding.
- ALARM OUT 1, 2 : Used to connect the alarm output signal.

## Alarm I/O Wiring Diagram

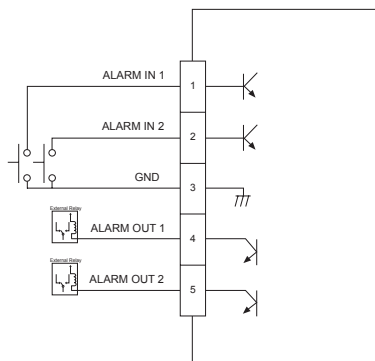

# INSTALLATION

## Precautions before installation

Ensure you read out the following instructions before installing the camera:

- Select an installation site (ceiling or wall) that can endure at least 5 times of the camera weight.
- Stuck-in or peeled-off cables can cause damage to the product or a fire.
- For safety purposes, keep anyone else away from the installation site. And put aside personal belongings from the site, just in case.

## OPTIONAL ACCESSORIES FOR INSTALLATION

For your easier installation, you can purchase appropriate optional accessories available.

### 1. WALL MOUNT ADAPTOR(SCX-300WM)/HANGING MOUNT(SCX-300HM)

This adaptor is used when installing the dome camera onto a wall.



### 2. CEILING MOUNT ADAPTOR(SCX-300CM)/HANGING MOUNT(SCX-300HM)

This adaptor is used when installing the dome camera on a concrete ceiling.

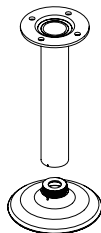

### 3. POLE MOUNT ADAPTOR(SCX-300PM)

This is an adaptor for WALL MOUNT ADAPTOR (SCX-300WM) installation on a pole whose diameter is bigger than 80mm.

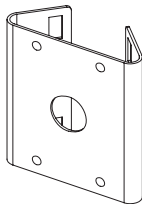

# installation & connection

---

4. CORNER MOUNT ADAPTOR (SCX-300KM)  
This is an adaptor for WALL MOUNT ADAPTOR (SCX-300WM) installation on the corner of wall joint.

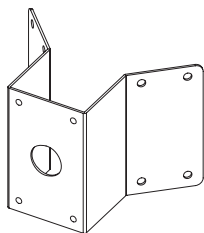

## Installing on the ceiling directly

1. Using the L-wrench provided, loosen 3 screws by turning them counterclockwise and separate the dome cover.

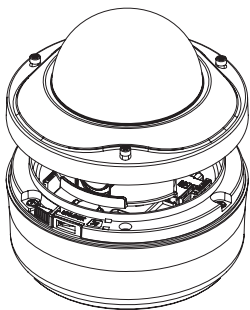

- Loosen 3 screws by turning them counterclockwise, press both left and right lock releases inwards (in arrow direction) to unlock the stopper, and then separate the camera from the case.

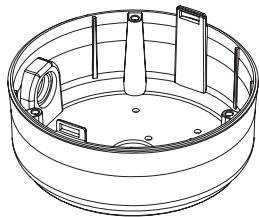
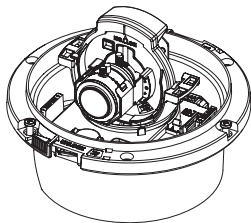

- Drill holes (diameter 5mm, more than 35mm deep) on the ceiling by matching to the holes on the case bed, and insert plastic anchors (HUD 5) fully into the holes. Fix the case bed on the ceiling by using Tapping Screws (TH M4xL30). (4 places)

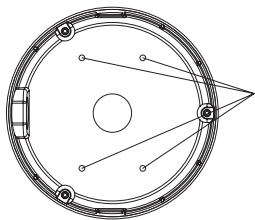

- Connect power and video cables and arrange cable running not to damage or squeeze them, and assemble the camera unit in the reverse way.
- Adjust the lens aiming to your desired direction.
- Assemble the Dome Cover.  
For waterproof purpose, fix and secure the bolt using L-wrench provided.

# installation & connection

---

## Flushed installation on the ceiling

1. Using the provided template, drill a hole for the camera unit and fixing holes (diameter 5mm, more than 35mm deep) on the ceiling. Insert the plastic anchors (HUR-5) fully into the fixing holes.
2. Separate the dome cover and case.  
For separating dome cover and case, refer to the steps 1 and 2 of **"Installing on the ceiling directly"**.
3. Connect power and video cables and arrange cable running not to damage or squeeze them.
4. Remove the case assembly screws from the camera module.
5. Insert the camera module into the camera hole, and install it by fastening the Tapping Screws (TH, M4xL30) by matching the fixing holes (3 places).
6. Assemble the Dome Cover.  
Refer tot the step 6 of **"Installing on the ceiling directly"**.

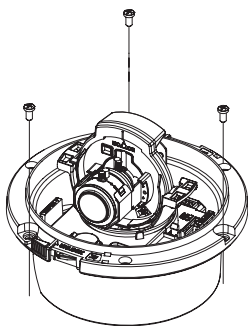



## Installing on adaptors (sold separately, SCX-300WM, 300CM, 300KM, 300PM)

1. Separate the dome cover and case.  
For separating dome cover and case, refer to the steps 1 and 2 of "**Installing on the ceiling directly**".
2. Assemble and secure the case and adaptor (sold separately) using 4 fixing screws (BH, M4xL8, provided).
3. Connect power and video cables and arrange cable running not to damage or squeeze them, and assemble the camera unit in the reverse way.
4. Assemble the Dome Cover.  
Refer tot the step 6 of "**Installing on the ceiling directly**".

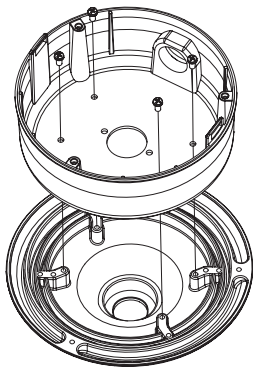

## Connecting additional alarm cables

1. Separate the dome cover and case to connect alarm cable.  
For separating dome cover and case, refer to the steps 1 and 2 of "**Installing on the ceiling directly**".
2. Tear off the long rubber plug as illustrated in the figure.
3. Through the hole opened in step 2 by tearing the plug off, insert the alarm cable and connect it to the alarm terminal of the PCB.
4. Assemble the camera module and the case.  
Refer tot the step 4 of "**Installing on the ceiling directly**".
5. Adjust the lens aiming to your desired direction and assemble the dome cover.

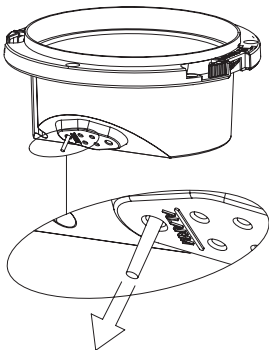

## Adjusting the monitoring direction for the camera

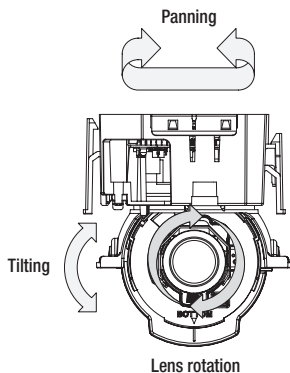

You can adjust the camera direction only when the camera is fixed on the ceiling. Then, turning the camera to the left or right is referred to as "Panning", while tilting the angle is "Tilting". For panning, the panning limit is 220° for the clockwise, and 120° for the counterclockwise, a total of 340° enabled; further rotation is stopped by the stopper.

# camera setup

You can configure the camera settings using the Web Viewer.



- For accessing the Web Viewer, refer to "Network Connection and Setup". (page 36)

## HOW TO USE THE MENU KEY

Follow the steps below if you run the Web Viewer for setting the menus.

- Launch the Web Viewer.
- From the [Camera OSD] menu in the left pane, click [Menu].  
The <MAIN MENU> screen appears.
- Click the Up/Down (▲▼) buttons to move to a desired item.
- Click the four direction (▲▼◀▶) buttons to navigate through the menu items.
- To change the value of a selected item, click the Left/Right (◀▶) buttons.
- Click [↵].  
Your changes will be applied.



- : Exits the menu setup screen.  
Before exiting the setup screen, select [SAVE] to save your settings, or [QUIT] to cancel them.
- : Saves your settings and returns to the previous screen.
- : Returns to the main menu.
- : Use this icon if you want to save your settings after you specified the mask area and privacy area, etc.  
Once you saved your settings, the changes remain intact even if you select [QUIT] on exit.
- : Use this icon if you want to delete a mask, or privacy area, etc.  
Once you deleted your settings, the deletions remain valid even if you select [QUIT] on exit.
- : This arrow appears next to a menu that contains sub items.

For the items with the "" mark on the right, You can get help from "Terminology". (page 74)



- If intelligent video analysis is enabled, camera's OSD menu operation can be set as an event.

# camera setup

## MAIN MENU

You can configure the camera settings to your preference.

- **PROFILE**  
You can select a mode that is appropriate to the camera installation environment.
- **CAMERA SET**  
Configure the camera functions and settings.
- **PRIVACY ZONE**  
You can configure the privacy settings.
- **OTHER SET**  
You can configure more settings including FACTORY DEFAULTS.
- **SYSTEM INFO**  
Shows the camera version and type.
- **LANGUAGE**  
Select a preferred one from the supported languages.



## PROFILE

You can select one from the pre-determined modes as appropriate to your specific camera installation environment.

Your selection on each item in PROFILE will affect all other settings of the camera. For the setting, refer to "PROFILE". (page 73)

For selecting and saving each menu item, refer to "How to use the menu key". (page 27)

- **STANDARD**  
Automatically optimizes the camera settings to the normal environment.
- **ITS**  
This setting enables you to analyze the traffic situation and take the traffic information at a glance.
- **BACKLIGHT**  
This setting enables you to view a sharp background and object even in a severe backlight scene.
- **DAY/NIGHT**  
Automatically optimizes the camera settings to the day and night scene.
- **GAMING**  
This automatically configures the settings so that you can work in a stable illumination condition as indoors.
- **CUSTOM**  
Your change to any of the PROFILE settings will switch the display to CUSTOM.



# CAMERA SETUP

You can configure the general settings of the camera module.

For selecting and saving each menu item, refer to "How to use the menu key". (page 27)

## CAMERA ID

Provide the ID and position for a camera that displays on the screen.

1. Select <CAMERA SET> - <CAMERA ID>.
2. Use the four direction (▲▼◀▶) buttons to select a desired character.  
In the lower input box of the screen, the selected character will be entered.
  - You can enter up to 54 characters including alphabets, numbers and special characters.
3. When done, continue to select <LOCATION> to specify the display position of the camera ID.

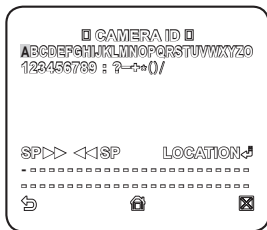

## IRIS

You can set the iris to control the intensity of radiation incoming to the camera.

1. Select <CAMERA SET> - <IRIS>.
2. Use the left/right (◀▶) buttons to select <ALC>.
  - ALC : Controls the luminance automatically.
    - LEVEL : Select the global brightness level.
    - BACKLIGHT : Select WDR or BLC.
    - WDR : Define the composition for weight factor, the shutter speed in WDR level, and select outdoor or indoor for white balance setup.
    - BLC (Backlight compensation) : Configure the backlight compensation area by defining the area size and location.



- If the iris is set to <ALC>, fixing the iris is your priority when you adjust AE and the shutter speed.

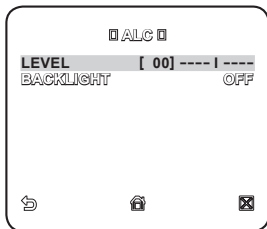

# camera setup

## MOTION

You can specify a level of AGC for controlling the camera motion.

Select F.FAST if you want to monitor a very fast moving object in a low contrast scene, and S.SLOW if monitoring a very slow moving, inanimate object in the same condition.

As long as DAY/NIGHT is set to AUTO, the <MOTION> menu is not available.

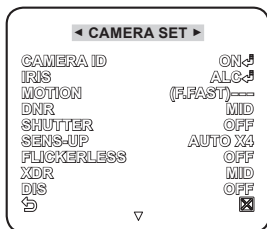

## DNR

Reduces the noise on the screen.

This is useful, especially for a noisy screen.

Set it to <USER>, you can specify the level.

## SHUTTER

The SHUTTER menu is used to set the fixed fast electronic shutter or auto fast electronic shutter.

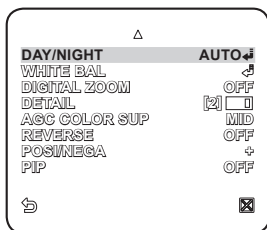

## SENS-UP

If the brightness of the video signal is too low, the Slow Shutter function will be activated. Slow Shutter can collect the individual max frame rate to adjust the setting.

## FLICKERLESS

If set to <ON>, the shutter speed will be fixed to 1/100 second. This will prevent possible screen distortion due to a mismatch between the vertical sync frequency and the blinking frequency of the lighting.

- If SHUTTER is set to AUTO, FIX, EXT mode / SENSE UP to FIX / AGC to FIX, the <DIS> menu will be disabled.

## XDR

This will correct a brightness difference between different scenes for the optimal visibility. The higher the value is, the higher the correction level is.

## DIS

Automatically compensates for the flicker on the screen.

If set to <ON>, the image will be enlarged with digital zoom as much area as compensated.

## DAY/NIGHT

You can specify a recording mode according to the scene.

- Select <CAMERA SET> - <DAY/NIGHT>.
- Select a screen transition mode according to the illumination, and set options as appropriate.
  - DAY : Fixed to DAY mode, regardless of the scene.
  - NIGHT : Fixed to NIGHT mode, regardless of the scene.  
If BURST is set to <ON>, the burst signal will output.
  - AUTO : According to the luminance, this will switch DAY to NIGHT mode, or vice versa.
  - DAY→NIGHT / NIGHT→DAY : If set to <AUTO>, you can specify the brightness level triggering the mode switch between DAY and NIGHT as well as the interval.
  - MASK AREA : If there exists a bright spot light source in a night scene, you can specify the size and position as needed.  
Any excessively bright area in a night scene will be masked.

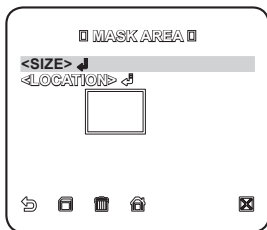
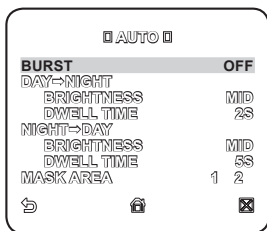

## WHITE BAL

If you need to adjust the screen brightness, use the WHITE BALANCE function.

- Select <CAMERA SET> - <WHITE BAL>.
- Select a mode where you set the balance.
  - DAY : You can set the RED, and BLUE value in DAY mode.
  - NIGHT : You can adjust the <WHITE BAL> according to the ambient luminance.

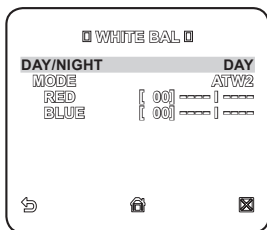

# camera setup

3. According to the specified recording mode, select a WHITE BAL mode with necessary options.

- BRIGHTNESS : Specify a brightness level triggering the switch from DAY to NIGHT mode.
- MODE : According to the selected mode, you can adjust the RED and BLUE color level.
  - RED : Adjust the strength of the red color.
  - BLUE : Adjust the strength of the blue color.
  - R-GAIN/B-GAIN : Specify the current color temperature manually.
    - You can set the R-GAIN, and B-GAIN value only in AWC mode.

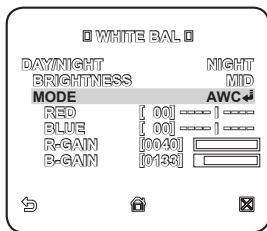

## DIGITAL ZOOM

You can set the digital zoom factor and position.

When the zoom factor and position are defined, the digital zoom function will operate.

- If you set the digital zoom to a larger factor than the actual enlargement for compensation, the DIS function will be disabled.

## DETAIL

You can adjust the vertical and horizontal sharpness, respectively.

## AGC COLOR SUP

This will adjust the color scheme according to the AGC value.

## REVERSE

This will reverse the signal left to right, top to bottom, or a combination of the preceding.

## POSI/NEGA

This will display the video brightness signal either normally or reversely.

## PIP

You can view a main image with a sub image on the same screen.



# PRIVACY ZONE

You can set up to 12 privacy zones that will be hidden for privacy of the subject when recording.

For selecting and saving each menu item, refer to "How to use the menu key". (page 27)

## ZONE SETUP

1. Select <MAIN MENU> - <PRIVACY ZONE>.
2. Use the four direction (▲▼◀▶) buttons to select a desired number.  
The Zone setup screen appears.

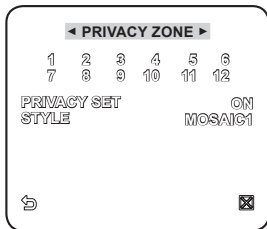

3. Select the <PIXEL LEVEL>.  
Specify the pixel unit level for the POSITION setting.
4. Select <POINT>.  
You will see dots on the screen.
5. Use the four direction (▲▼◀▶) buttons to specify the position for each of the four dots.
6. Select <POSITION> and use the four direction (▲▼◀▶) buttons to specify the position for each of the four dots.
7. Save the changes and move to the previous screen and select the <STYLE>.  
Select <COLOR> and pick a desired color.

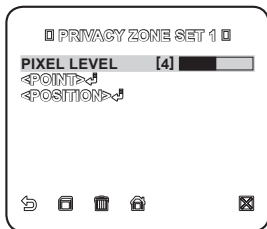

-  ■ Setting one or more privacy zone and enabling privacy function will disable the PIP function.

## OTHERS

---

You can reset the camera, or select the OSD font color to your preference.

For selecting and saving each menu item, refer to "How to use the menu key". (page 27)

### FACTORY DEFAULT

1. Select <MAIN MENU> - <OTHER SET>  
- <FACTORY DEFAULTS>.

The FACTORY DEFAULTS setup screen appears.

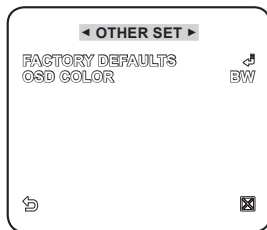

2. Select <OK>.

All the settings will be restored to the factory default.

However, the language setting will not be restored.

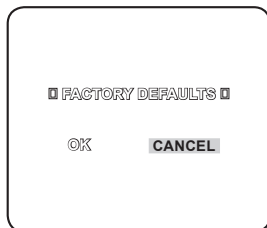

### OSD COLOR

You can set the font color of the user interface.

## SYSTEM INFO

You can check the system information.

For selecting and saving each menu item, refer to "How to use the menu key". (page 27)

1. Select <MAIN MENU> - <SYSTEM INFO>.
2. The current system information is displayed.



- The camera type may different, depend on the video signal.

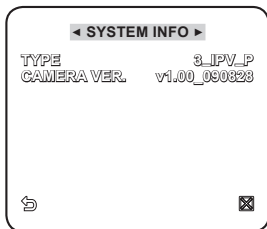

## LANGUAGE

You can select a language to your preference.

For selecting and saving each menu item, refer to "How to use the menu key". (page 27)

1. Select <MAIN MENU> - <LANGUAGE>.
2. Select your preferred language using the up/down (▲▼) buttons.



- Supported language may different.



# network connection and setup

You can set up the network settings according to your network configurations.

## CONNECTING THE CAMERA TO AN IP ROUTER WITH THE XDSL/CABLE MODEM

This is for a small network environment such as homes, SOHO and ordinary shops.

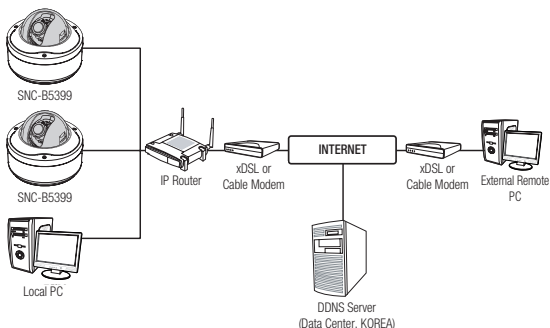

### Configuring the network settings of the local PC connected to an IP router

Configuring the network settings of the local PC connected to an IP router, follow the instructions below.

- Select : <Network Neighborhood> → <Properties> → <Local Area Connection> → <Properties> → <General> → <Internet Protocol (TCP/IP)> → <Properties> → <Obtain an IP address automatically> or <Use the following IP address>.
- Follow the instructions below if you select <Use the following IP address>:
  - ex1) If the address (LAN IP) of the IP router is 192.168.1.1  
IP address: 192.168.1.100  
Subnet Mask: 255.255.255.0  
Default Gateway: 192.168.1.1
  - ex2) If the address (LAN IP) of the IP router is 192.168.0.1  
IP address: 192.168.0.100  
Subnet Mask: 255.255.255.0  
Default Gateway: 192.168.0.1
  - ex3) If the address (LAN IP) of the IP router is 192.168.xxx.1  
IP address: 192.168.xxx.100  
Subnet Mask: 255.255.255.0  
Default Gateway: 192.168.xxx.1



- For the address of the IP router, refer to the product's documentation.

## Checking if the IP router is connected to the xDSL/Cable modem properly

Select <Status> from the Settings menu of the IP Router

- If it is properly connected, <IP Address>, <Subnet Mask> and <Gateway> provided by your ISP are displayed. Please remember these values because they are required so that an external remote computer of the IP router connects to the camera. However, note that certain ISPs change the settings of <IP Address>, <Subnet Mask> and <Gateway> on a regular basis
- If the IP router is not properly connected, press the [Connect] button to try to reconnect or check if the settings of the IP router are correct.

## CONNECTING THE CAMERA TO AN IP ROUTER WITH LOCAL AREA NETWORKING

This is for a large network environment such as corporate office, building, public office and factory.

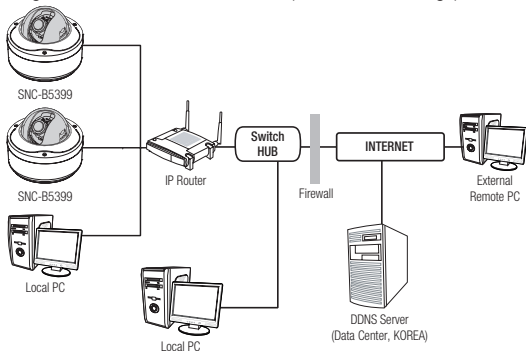

### Configuring the network settings of the local PC connected to an IP router

Configuring the network settings of the local PC connected to an IP router, follow the instructions below.

- Select : <Network Neighborhood> → <Properties> → <Local Area Connection> → <Properties> → <General> → <Internet Protocol (TCP/IP)> → <Properties> → <Obtain an IP address automatically> or <Use the following IP address>.
- Follow the instructions below if you select <Use the following IP address>:
  - ex1) If the address (LAN IP) of the IP router is 192.168.1.1  
 IP address: 192.168.1.100  
 Subnet Mask: 255.255.255.0  
 Default Gateway: 192.168.1.1
  - ex2) If the address (LAN IP) of the IP router is 192.168.0.1  
 IP address: 192.168.0.100  
 Subnet Mask: 255.255.255.0  
 Default Gateway: 192.168.0.1

# network connection and setup

ex3) If the address (LAN IP) of the IP router is 192.168.xxx.1  
IP address: 192.168.xxx.100  
Subnet Mask: 255.255.255.0  
Default Gateway: 192.168.xxx.1



- For the address of the IP router, refer to the product's documentation.

## CONNECTING THE CAMERA DIRECTLY TO A DHCP-BASED XDSL/CABLE MODEM

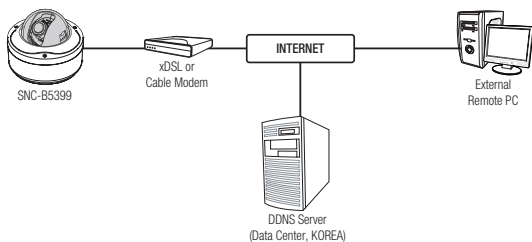

### Setting the IP Router

This is enabled for a modem using DHCP.

1. Set the Static or Dynamic IP address. (pages 41~45)
2. Launch an Internet browser on the local PC connected to the IP Router.
3. Enter the IP Router's address in the address bar of the browser.  
ex) `http://192.168.1.1`, `http://192.168.0.1`  
or `http://192.168.xxx.1`
  - For the DDNS URL address, refer to "To check the DDNS address". (page 48)
4. When the IP Router is connected, the login window appears and prompts you to enter the password.
  - For the login IP and the password, refer to the IP router's documentation.
5. When done, you will see the setup window of the IP router. In the setup menu, select "**Automatic Configuration-DHCP**" for Internet Connection Type.
  - For the menu location of Internet Connection Type or DHCP selection, refer to the IP router's documentation.
6. When done, click the [Save] or [Apply] button to save the settings.

# CONNECTING THE CAMERA DIRECTLY TO LOCAL AREA NETWORKING

## Connecting to the camera from a local PC in the LAN

1. Launch an Internet browser on the local PC.
2. Enter the IP address of the camera in the address bar of the browser.

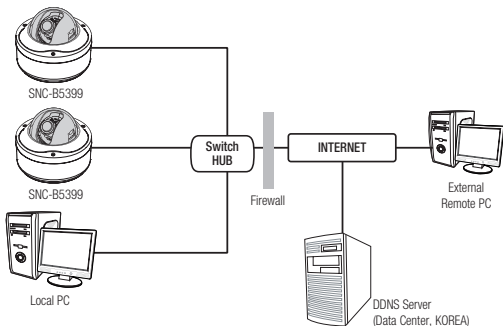

- A remote PC in an external Internet out of the LAN network may not be able to connect to the camera installed in the intranet if the port-forwarding is not properly set or a firewall is set. In this case, to resolve the problem, contact your network administrator.

# network connection and setup

## IP ADDRESS SETUP

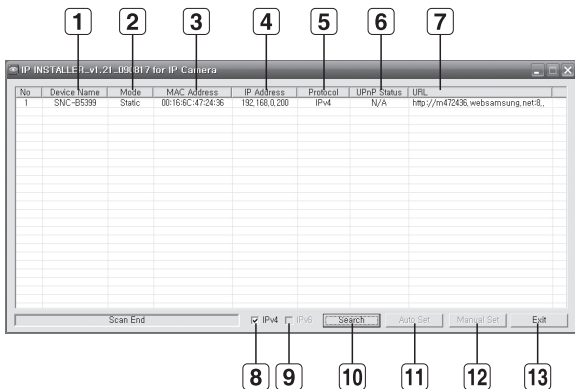

### Buttons used in IP Installer

Item	Description
<b>1</b> Device Name	Model name of the connected camera. Click the column to sort the list by model name. However, search will be stopped if clicked during the search.
<b>2</b> Mode	Displays either <Static> or <Dynamic> for the current network connection status.
<b>3</b> MAC(Ethernet) Address	Ethernet address for the connected camera. Click the column to sort the list by Ethernet address. However, search will be stopped if clicked during the search.
<b>4</b> IP Address	IP address. Click the column to sort the list by IP address. However, search will be stopped if clicked during the search. The factory default is "192.168.1.200".
<b>5</b> Protocol	Network setting for the camera. The factory default is "IPv4". Cameras with the IPv6 setting will be displayed "IPv6".
<b>6</b> UPnP Status	This function is not currently implemented.



<b>7</b>	<b>URL</b>	DDNS URL address enabling access from the external Internet. However, this will be replaced with the <IP Address> of the camera if DDNS registration has failed.
<b>8</b>	<b>IPv4</b>	Scans for cameras with the IPv4 setting.
<b>9</b>	<b>IPv6</b>	Scans for cameras with the IPv6 setting.
<b>10</b>	<b>Search</b>	Scans for cameras that are currently connected to the network. However, this button will be grayed out if neither IPv4 nor IPv6 is checked.
<b>11</b>	<b>Auto Set</b>	<IP Installer> will automatically configure the network settings for you.
<b>12</b>	<b>Manual Set</b>	You should configure the network settings manually.
<b>13</b>	<b>Exit</b>	Exits the IP Installer program.

## STATIC IP SETUP

### Manual Network Setup

Run <IP Installer.exe> to display the camera search list.

At the initial startup, both [Auto Set] and [Manual Set] will be grayed out.

-  ■ For cameras found with the IPv6 setting, these buttons will be grayed out as the cameras do not support this function.

1. Select a camera in the search list.  
Find the MAC (Ethernet) address labeled on the rear of the camera.  
Both the [Auto Set] and [Manual Set] buttons will be activated.

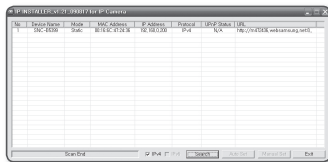

2. Click [Manual Set].  
The MANUAL SET dialog appears.  
The default values of <IP Address>, <Subnet Mask>, <Gateway>, and <HTTP Port> of the camera will be displayed.  
The default <PASSWORD> is 4321.

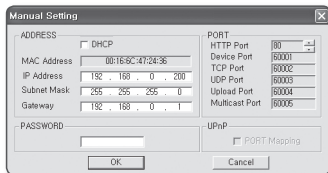

3. In the <ADDRESS> pane, provide the necessary information.  
MAC (Ethernet) Address : The MAC (Ethernet) address of the applicable camera will be set automatically so you don't need to input it manually.

# network connection and setup

## If using an IP router :

- IP Address : Enter an address falling in the IP range provided by the IP router.  
ex) 192.168.1.2~254,  
192.168.0.2~254,  
192.168.XXX.2~254
- Subnet Mask : The <Subnet Mask> of the IP router will be the <Subnet Mask> of the camera.
- Gateway : The <Local IP Address> of the IP router will be the <Gateway> of the camera.

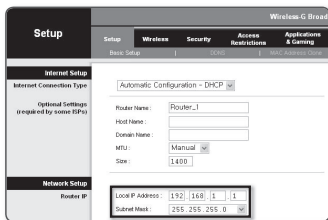

## If not using an IP router :

For setting <IP Address>, <Subnet Mask>, and <Gateway>, contact your network administrator.



- The values of Device, TCP, UDP, Upload, and Multicast ports can not be changed manually, and will be adjusted according to the HTTP port value.

## 4. In the <PORT> pane, provide necessary information.

- HTTP Port : Used to access the camera using the Internet browser, defaulted to 80. Use the spin button to change the HTTP Port value. The start value of the port is 80, and increases or decreases by 6 like 10000, 10006, 10012.
  - Device Port : Used to control the video signal transfer, defaulted to 60001(TCP).
  - TCP Port : Video signal transfer port using TCP protocols, defaulted to 60002(TCP).
  - UDP Port : Video signal transfer port using the UDP Unicast method, defaulted to 60003(UDP).
  - Upload Port : Used to upgrade the software firmware, defaulted to 60004(TCP).
  - Multicast Port : Video signal transfer port using the UDP Multicast method, defaulted to 60005(UDP).
5. Enter the password.  
This is the login password for the "root" user who accesses the camera.  
The default password is "4321".

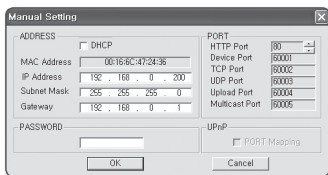

6. Click [OK].

Manual network setup will be completed.

7. When the manual setup including <IP> is completed, the camera will restart.

### If the IP router has more than one camera connected

Configure the IP related settings and the Port related settings distinctly with each other.

Category		Camera #1	Camera #2
IP related settings	IP Address	192.168.1.200	192.168.1.201
	Subnet Mask	255.255.255.0	255.255.255.0
	Gateway	192.168.1.1	192.168.1.1
Port related settings	HTTP Port	80	10000
	Device Port	60001	10001
	TCP Port	60002	10002
	UDP Port	60003	10003
	Upload Port	60004	10004
	Multicast Port	60005	10005



- If the <HTTP Port> is set other than 80, you must provide the <PORT> number in the address bar of the Internet browser before you can access the camera.

ex) http://IP address : HTTP Port

http://192.168.1.201:10000

## Auto Network Setup

Run <IP Installer.exe> to display the camera search list.

At the initial startup, both [Auto Set] and [Manual Set] will be grayed out.



- For cameras found with the IPv6 setting, these buttons will be grayed out as the cameras do not support this function.

1. Select a camera in the search list.

Find the MAC (Ethernet) address labeled on the rear of the camera.

Both the [Auto Set] and [Manual Set] buttons will be activated.

2. Click [Auto Set].

The AUTO SET dialog appears.

The <IP Address>, <Subnet Mask>, and <Gateway> will be set automatically.

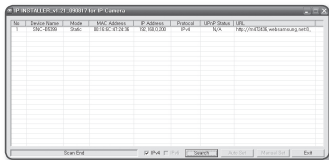

# network connection and setup

3. Enter the password.  
This is the login password for the "root" user who accesses the camera.  
The default password is "4321".
4. Click [OK].  
Auto network setup will be completed.
5. The camera will automatically complete the network setting and restart.

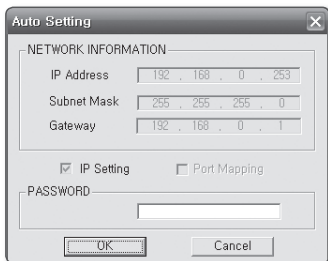

## DYNAMIC IP SETUP

### Dynamic IP Environment Setup

- Example of the dynamic IP environment
  - If an IP router, with cameras connected, is assigned an IP address by the DHCP server
  - If connecting the camera directly to the xDSL or cable modem using the DHCP protocols
  - If IPs are assigned by the internal DHCP server via the LAN

### Checking the dynamic IP

1. From a local PC, run <IP Installer> to display a list of cameras that are assigned <Dynamic IP>.
2. Select a camera in the list, and click [Manual Set] to check the <Dynamic IP> of the camera.  
If you uncheck <DHCP>, you can change <IP> or <PORT> to <STATIC>.

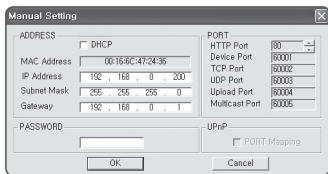
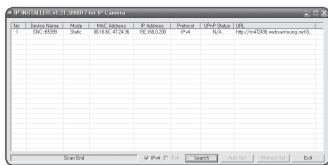

# PORT RANGE FORWARD (PORT MAPPING) SETUP

If you have installed an IP router with a camera connected, you must set the port range forwarding on the IP router so that a remote PC can access the camera in it.

## Manual Port Range Forwarding

1. From the Setup menu of the IP router, select **<Applications & Gaming>** - **<Port Range Forward>**.

For setting the port range forward for a third-party IP router, refer to the user guide of that IP router.

2. Select **<TCP>** and **<UDP Port>** for each connected camera to the IP router.

Each port number for the IP router should match that specified in **<Basic>** - **<IP>** from the camera's Setup menu.

3. When done, click **[Save Settings]**. Your settings will be saved.

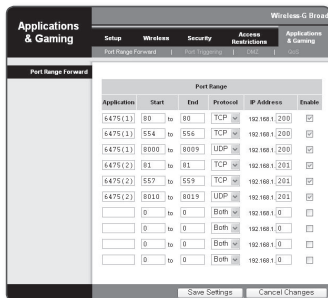

# network connection and setup

## CONNECTING TO THE CAMERA FROM A SHARED LOCAL PC

1. Launch <IP Installer>.  
It will scan for connected cameras and display a list of them.
2. Double-click a camera to access.  
The Internet browser starts and connects to the camera.

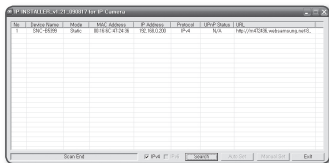

- You can also access the camera in such way you type the IP address of the found camera in the address bar of the Internet browser.

## CONNECTING TO THE CAMERA FROM A REMOTE PC VIA THE INTERNET

As a remote PC can not directly access <IP Installer>, you should access the camera in the IP router network using DDNS URL of the camera.

1. Before you can access a camera in the IP router network, you should have set the port range forward for the IP router.
2. From the remote PC, launch the Internet browser and type the DDNS URL address of the camera, or the IP address of the IP router in the address bar.  
ex) <http://mffe42.websamsung.net>
  - For the DDNS URL address, refer to "**To check the DDNS address**". (page 48)

## CONNECTING TO THE CAMERA

### Normally, you would

1. Launch the Internet browser.
2. Type the IP address of the camera in the address bar.
  - ex) • IP address (IPv4) : 192.168.1.200  
→ http://192.168.1.200
  - the Login dialog should appear.
  - IP address (IPv6) : 2001:230:abcd:ffff:0000:0000:ffff:1111  
→ http://[2001:230:abcd:ffff:0000:0000:ffff:1111]

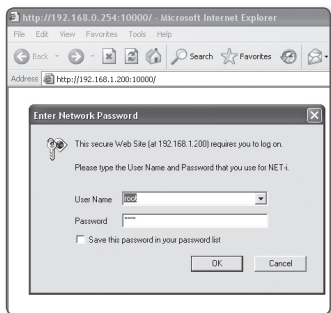

### If the HTTP port is other than 80

1. Launch the Internet browser.
2. Type the IP address and HTTP port number of the camera in the address bar.
  - ex) IP address : 192.168.1.200:Port number(10000) → http://192.168.1.200:10000
  - the Login dialog should appear.

### Using URL

1. Launch the Internet browser.
2. Type the DDNS URL of the camera in the address bar.
  - ex) URL address : http://mfffe42.websamsung.net
  - the Login dialog should appear.

### Connecting via URL (If the HTTP port is other than 80)

1. Launch the Internet browser.
2. Type the DDNS URL and HTTP port number of the camera in the address bar.
  - ex) URL address : http://mfffe42.websamsung.net:Port number(10000)
  - http://mfffe42.websamsung.net:10000
  - the Login dialog should appear.

## To check the DDNS address

The DDNS address consists of: <one of the lower-case letters: c, m, p> + <the last 6 digits of the MAC (Ethernet) address> + <websamsung.net>

The small letter will be <c> if the first 6 digits of the MAC (Ethernet) address is <00:00:f0>, or <m> if they are <00:16:6c>, or <p> for <00:68:36>.

- ex) - If the MAC (Ethernet) address is 00:00:f0:ff:fe:42: c + ffe42 + websamsung.net = cffe42.websamsung.net
- If the MAC (Ethernet) address is 00:16:6c:ff:fe:42: m + ffe42 +websamsung.net = mffe42.websamsung.net
- If the MAC (Ethernet) address is 00:68:36:ff:fe:42: p + ffe42 +websamsung.net = pffe42.websamsung.net



- The above mentioned addresses are simply examples; do not use any of these for connecting purposes.

## LOGIN

---

The default user ID is "**root**", and the default password is "**4321**".

1. Enter "**root**" in the <User Name> input box.
2. Enter "**4321**" in the <Password> input box.  
If the password is changed, enter the changed password instead.
3. Click [OK].  
If you have logged in successfully, you will the Live Viewer screen.

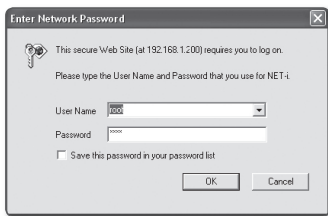

- For security purposes, ensure that you change the password in <Basic> - <User>. The administrator ID, "**root**", is fixed and can not be changed.
- If you check the "**Save this password in your password list**" option when your input is done, you will be logged in automatically without being prompted to enter the login information from next time on.



- For this, your computer has installed DirectX 8.1 or later.  
You can get a free download of the latest DirectX from <http://www.microsoft.com/download>.  
If you are using Internet Explorer 7.0 or 8.0 as the default web browser, you can view the best quality image with a screen ratio of 100%. Reducing the ratio may cut the image on the borders.



# INSTALLING ACTIVEX

If connecting to a camera for the first time, you will see the installation message. Then, install the required ActiveX to access the camera and control the video from it in real time.

## For Windows XP Service Pack 2 users

1. Click the installation message that pops up when you first access the camera.

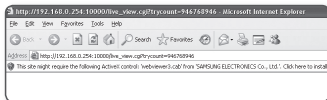

2. Click <Install ActiveX Control...>.



3. The security warning popup appears, click [Install].



4. When the required ActiveX is installed properly after your access to the camera, the Live screen should appear.



- For normal installation, set the Block Popup setting as follows:  
**Internet Explorer → Tools → Block Popup → Always allow popups from the current site(A)**

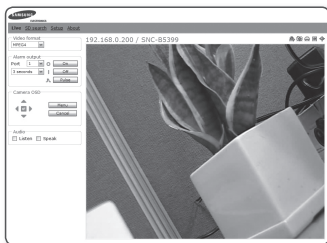

## USING THE LIVE SCREEN

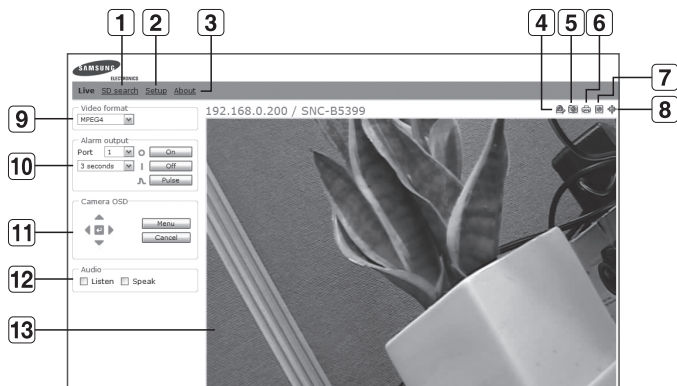

Item	Description
<b>1</b> SD Search	Moves to the screen for searching event images from the SD card.
<b>2</b> Setup	Move to the Setup screen.
<b>3</b> About	You can check the firmware version, serial number and manufacturer information.
<b>4</b> Reset Alarm	Resets the Alarm icon. (Alarm and Intelligent Video Analysis icons will disappear.)
<b>5</b> Capture	Saves the snapshot as an image file in the .jpeg or .bmp format.
<b>6</b> Print	Prints out the current image.
<b>7</b> Record	Records the current video in avi movie file format.
<b>8</b> Full Screen	Displays the Live screen in full screen.
<b>9</b> Video format	You can set the video format(MJPEG, H.264/MPEG4) for video files. Note that the menu configuration may differ from your setup of <H.264 & MPEG4 video select> in Video Setup menu.

<b>10</b> Alarm output	On : Activates the specified Alarm Out port. Off : Deactivates the specified Alarm Out port. Pulse : Activates the Alarm Out port as much time as specified before deactivating it.
<b>11</b> Camera OSD	Used to retrieve and customize the Camera Setup menu. For selecting and saving each menu item, refer to "How to use the menu key". (page 27)
<b>12</b> Audio	Check the Listen or Speak check box for Audio.
<b>13</b> Viewer Screen	Displays the Live video on the screen.

## BACKUP

You can capture, print out, and save the snapshot in the specified path.

### To capture the snapshot

1. Click  on the scene to capture.  
The Capture dialog should appear.
2. Click **[OK]**.  
The screenshot will be saved in the specified path.

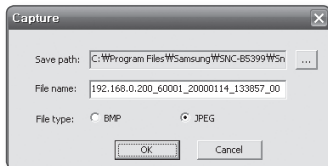



- Default file path
  - Windows XP : C:\Program Files\Samsung\SNC-B5399\SnapShot\Live  
If you want to change the path, click **[Set path (...)]** and specify a path.
  - Windows Vista : C:\users\[UserID]\AppData\LocalLow\Samsung\SNC-B5399\SnapShot\Live  
On the Windows Vista system, the path to save is fixed.
- The screenshot file will be named automatically in the format of <IP address\_Port number\_YYYYMMDD\_hhmmss\_index>.  
ex) 192.168.0.200\_60001\_20000114\_133857\_00

## To print out the screenshot

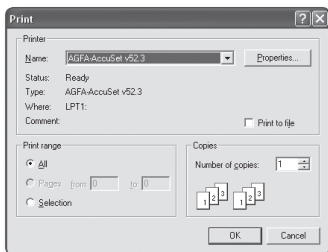
1. Click  on the scene to print out.  
The Print setup dialog appears.
2. Specify the name of the printer connected, and click **[OK]**.



## To record a video

1. Click  on the scene to record.
2. You will see the Save AVI dialog; provide the necessary information.
  - Save path : You can change the default saving path.
  - File name : You can change the default file name.
  - HDD minimum free size : If the free space on the HDD is less than the recorded space, recording will be forcibly ended.
3. Click **[OK]**.  
Recording will start with the display of **<REC>** on the viewer screen.  
The video file will be saved into the specified path.
4. If you want to quit recording, click  again.

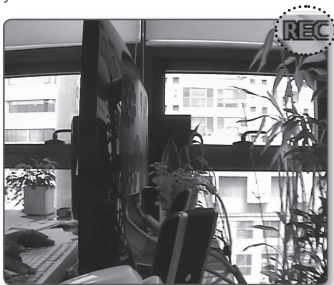
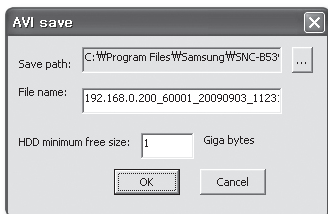

- Default file path
  - Windows XP : C:\Program Files\Samsung\SNC-B5399\VideoClip\Live  
If you want to change the path, click [**Set path** (...)] and specify a path.
  - Windows Vista : C:\users\[UserID]\AppData\LocalLow\Samsung\SNC-B5399\VideoClip\Live  
On the Windows Vista system, the path to save is fixed.
- The screenshot file will be named automatically in the format of <IP address\_Port number\_YYYYMMDD\_hhmmss\_index>.  
ex) 192.168.0.200\_60001\_20090903\_112357\_00
- If you want to play an .avi file, you must have installed the corresponding DivX codec on your system.  
You can get a free download of the DivX from <http://sourceforge.net/projects/ffdshow/>.

## USING THE SD SEARCH VIEWER SCREEN

1. Click <SD search> tab in the Live screen.
2. The SD Search Screen appears.

### SD Search Viewer Screen layout

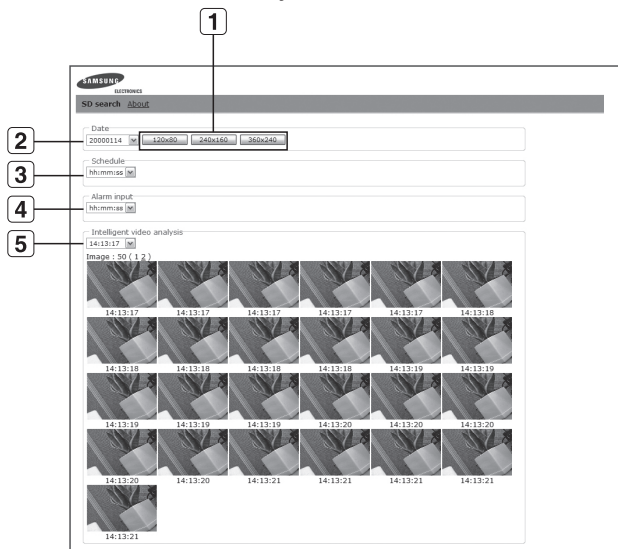

Name	Function and description
1 Thumbnail Size	The thumbnail images are displayed based on the selected size.
2 Date	You can select the desired date to search for events generated.
3 Schedule	You can select the desired time to search the schedule events.
4 Alarm input	You can select the desired time to search the alarm events.
5 Intelligent video analysis	You can search for events of intelligent video analysis by specifying the time period.

# setup screen

## ACCESSING THE SETUP SCREEN

You can configure the default setting, system, overlay, event and network related settings, and change them as necessary.

1. In the Live screen, click the <Setup> tab.
2. The Setup screen appears.

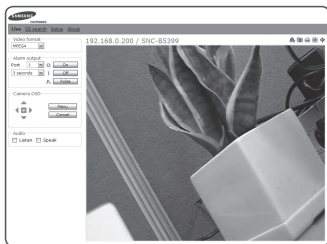

## DEFAULT SETUP

### To configure the video & audio settings

You can set the video resolution, quality, CODEC and audio input/output settings.

1. Select <Basic> - <Video & Audio>.  
The Video & Audio setup screen appears.
  - Brightness : Adjust the screen brightness from 1 to 100.
  - Contrast : Adjust the contrast from 1 to 100.
  - Resolution : Set the video size of the MPEG4, H.264, and MPEG files.
    - NTSC : 4CIF(704x480), VGA(640x480), CIF(352x240)
    - PAL : 4CIF(704x576), VGA(640x480), CIF(352x288)
  - Quality : Adjust the picture quality from 1 to 10.
  - Frame rate : Select one from 30 fps, 15 fps, 8 fps, 3 fps, and 1 fps.
  - Bitrate control\* : Select CBR (Constant Bit Rate) or VBR (Variable Bit Rate) for the compression method.
    - If selecting VBR, you can not set the target bit rate.

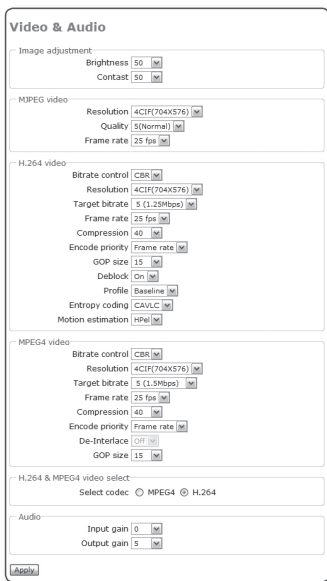

# setup screen

---

- Target bitrate : Transfers video signal at a specified bit rate.
- Compression : Adjust the compression rate from 5 through 100 by 5.
- Encode priority : Set the video transfer method to Frame rate or Quality.
- GOP\* size : Select a GOP size between 5 and 15.
- Deblock : This will soften the edges between macro blocks.
- De-Interlace : You can reduce the grid noise by using the de-interlacing function. Only available if MPEG4 resolution is set to 4CIF.



▪ If the WDR is set to <OFF> or the MPEG4 resolution is not 4CIF, you cannot enable the MPEG4 CODEC's de-interlacing

- Profile : Select Baseline or Main for the H.264 profiling method.
- Entropy coding\* : Reduces the compression loss due to encoding.
- Motion estimation : Estimates the movement of pixels by determining the motion vector.
- Input gain : You can set the audio input gain from 0 to 10.
- Output gain : You can set the audio output gain from 0 to 10.



▪ If the audio input gain is set to 0, no sound is heard.

2. When done, click **[Apply]**.  
Your settings will be saved.



## To configure the IP settings

### 1. Select <Basic> - <IP>.

The IP setup window appears.

- IP configuration : Set the IP and port settings for the camera.
  - IP type : Select one from <Static IP>, <Dynamic IP>, and <PPPoE IP>.
    - If you select <PPPoE IP>, you can provide the optional ADSL IP and password. However, the multicast items (multicast address, port, TTL) for VNP and RTP will disappear.
  - MAC address : Displays the Ethernet MAC address. This is used for creating a DDNS address.
  - IP address : Displays the current IP address.
  - Subnet mask : Displays the <Subnet mask> for the set IP.
  - Gateway : Displays the <Gateway> for the set IP.
  - DNS server : Displays the DNS(Domain Name Service) server address.
  - HTTP webserver port : HTTP port used to access the camera via the web browser. The default is 80(TCP).
  - Upload port (TCP) : Used to upgrade the software firmware, defaulted to 60004(TCP).
- IPv6 configuration : Obtains the IPv6 address to access the IPv6 network.
- VNP configuration : Set a port used to transfer video signals with the Samsung protocols.
  - Device port (TCP) : Used to control the video signal transfer, defaulted to 60001(TCP).
  - TCP streaming port : Video signal transfer port using TCP protocols, defaulted to 60002(TCP).
  - UDP streaming port : UDP Port used to transfer video signal with the UDP Unicast protocols. The default is 60003(UDP).
  - Multicast address : IP address used to transfer video signal with the UDP Multicast protocols. The default is 225.128.1.128, and if you want to change the address, specify it ranging from 224.0.0.0 to 239.255.255.255.
  - Multicast port : UDP Port used to transfer video signal with the UDP Multicast protocols. The default is 60005(UDP).
  - TTL\* : Set the TTL for the VNP packet. The default is 63, and if you want to change the address, specify it ranging from 0 to 255.

The screenshot shows the 'IP' configuration window with the following fields and values:

- IP configuration:**
  - IP type: Static IP
  - MAC address: 00:16:6c:4f:20:5a
  - IP address: 192.168.0.254
  - Subnet mask: 255.255.255.0
  - Gateway: 192.168.0.1
  - DNS server: 168.126.63.1
  - HTTP webserver port: 10000
  - Upload port (TCP): 10004
- IPv6 configuration:**
  - IPv6 enable:
- VNP configuration:**
  - Device port (TCP): 10001
  - TCP streaming port: 10002
  - UDP streaming port: 10003
  - Multicast address: 225.128.1.128
  - Multicast port: 10005
  - TTL: 63
- RTP configuration:**
  - RTSP port: 354
  - Streaming port: 61000 ~ 61999
  - Multicast address: 225.128.1.128
  - Multicast port: 62000
  - TTL: 63

An 'Apply' button is located at the bottom left of the window.

# setup screen

---

- RTP configuration : You can set the RTP protocol.
  - RTSP port : You can set the RTSP port.
  - Streaming port : Used to transfer video signal with the RTP protocols. The default range is between 61000 and 61999.
  - Multicast address : IP address used to transfer video signal with the RTP protocols.
  - Multicast port : Used to transfer video signal with the RTP-protocol multicasting.
  - TTL\* : You can set the TTL for the RTP packet.

## 2. When done, click **[Apply]**.

Your settings are saved and the system restarts.

The currently opened web browser will be closed.



- If the IP router has more than one camera connected, you should configure IP and port settings differently with each other.

## To set the user account

### 1. Click **<Basic>** - **<User>**.

The User setup window appears.

- Login authentication : You can set to authenticate the login by the user.
  - If you select **<Enable>**, the user should have gone through the login authentication; if selecting **<Disable>**, every user can access the system without the login authentication, having the ordinary user permissions.
  - When done, click **[Apply]**. Your settings will be saved.

Select	User ID	Password	Level
<input type="radio"/>	root	****	Administrator

### 2. Add users or edit user ID or password.

- User login ID/password list : Displays a list of accessible users ID, passwords, and ratings.
  - You can add up to 10 users.
  - The admin ID is "root".
  - The password for the admin ID can be changed, but not added or deleted.

## User Registration

- From the User setup window, click **[Insert]**.  
The Register User window appears.
- Provide the <User ID>, <Password>, and <Confirm password>, respectively. You can enter up to 9 alphanumeric or special characters (some excluded) for the user ID and password, respectively.
- Select a user level.  
Select either <Operator> or <User> for a new user's permission.
- Click **[Apply]**.  
The user registration is completed.

Insert user

User ID

Password

Confirm password

Level **Operator** ▼

**Apply** **Cancel**

- ! ■ An existing user ID can not be added duplicate.
- Neither root ID nor guest ID can be registered.

## To edit a registered user account

- From the User setup window, select a user ID to change.
- From the User setup window, click **[Modify]**.  
The Modify user window appears.
- Change the <User ID>, <Password>, <Confirm password>, and <Level> as you wish.
- Click **[Apply]**.  
The selected user ID will be changed.

Modify user

User ID

Password

Confirm password

Level **Administrator** ▼

**Apply** **Cancel**

## To delete a user ID

- From the User setup window, select a user ID to delete.
- From the User setup window, click **[Delete]**.  
The selected user ID will be deleted.



### ■ About the user permission

Administrator : Can use all functions (change/control settings).

Operator : Can use only the functions available in the Live Viewer.

User : Can only view the video on the Live Viewer.

# setup screen

---

## To set the display language

1. Click **<Basic>** - **<Language>**.  
The Language setup window appears.  
You can select one from 7 languages  
(English/Korean/Chinese/French/Italian/  
Spanish/German).
2. When done, click **[Apply]**.  
The selected language will be applied.

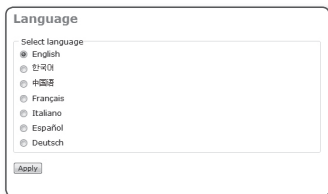

## SYSTEM SETUP

---

### To set the date/time

You can obtain the current system time from the NTP server or your PC for your time setting.

1. Select **<System>** - **<Date & Time>**.  
The Date & Time setup window appears.
2. If you select Manual, input the date and time manually.  
Your settings will be saved.
  - Current system time : The specified time in System Time Setup will be applied.
  - System time setup : You can synchronize the system time with the NTP server (time server) or your PC, or specify it manually.

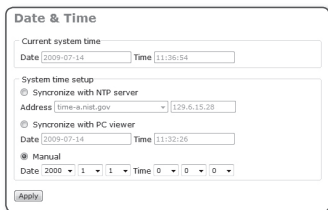

- You can specify the time between January 1, 2000 and December 31, 2037.

## To set the system time

1. Select a desired address in <Address> or select <Synchronize with PC viewer>.

2. If you select Manual, input the date and time manually.

3. Click [Apply].

The specified system time will be applied.



<NTP Server IP> is provided by a public agency, the list of which is subject to change from time to time.

In a local network, a separate NTP server must be manually defined.



The current time can vary depending on the computers regional (GMT and DST) and country (PC time configuration) settings.

## To check the log information

Select <System> - <Log>.

The Log information list appears.

• **System log list** : Shows the log information about the system changes along with time and IP address.

- System started: When the camera turns on
- User login: When the user logs in to the camera
- System restarted: When the camera restarts
- Network is up: When accessing the network
- Network is down: When not accessing the network
- Video param. changed: When the video related parameters are changed
- System time changed: When the system time is changed
- Network configuration change: When the network related configurations are changed
- Alarm occurrence 1, 2: When an alarm is generated
- Intelligent Video Analysis occurrence: When an intelligent video analysis event is generated.
- FTP send error: When FTP transfer failed
- SMTP send error: When sending e-mail message through SMTP server fails.

Time	Item	IP
2009-07-14 11:24:52	User login	192.168.0.65
2009-07-14 11:24:46	User login	192.168.0.65
2009-07-14 11:18:17	User login	192.168.0.65
2009-07-14 11:17:42	Network is up	192.168.0.254
2009-07-14 11:17:27	User login	192.168.0.65
2009-07-14 11:17:16	System started	192.168.0.254
2009-07-14 11:10:55	User login	192.168.0.65
2009-07-14 11:10:01	User login	192.168.0.65
2009-07-14 11:08:28	User login	192.168.0.65
2009-07-14 11:08:10	User login	192.168.0.65
2009-07-14 11:00:56	User login	192.168.0.65



The maximum of 2000 logs can be recorded.

If the log number is over 2000, the log in the bottom of the log list will be replaced with a new log.

# setup screen

## To update the software

Select **<System>** - **<Software update>**.  
The Software update window appears.

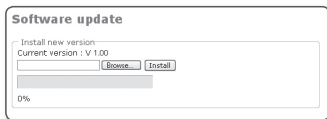

## How to update the software

1. From the software update window, click **[Browse...]**.  
The Open dialog appears.
2. Select an updatable file and click **[Open]**.
3. From the software update window, click **[Install]**.  
The selected file will be unzipped with a start of the update.  
It may take a several minutes to complete the update.
4. When the software update is completed, you will be prompted to restart the system.
5. Click **[OK]** to restart the system.  
Since the current connection is disconnected, you have to connect to the system again.

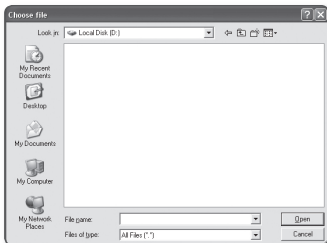

-  If the network is disconnected, the power supply fails, or the PC abnormally operates during the update, the system does not work at all.

## To reset the system

Restart or reset the system if it does not work properly or causes a problem.

Select **<System>** - **<Reset>**.  
The Reset window appears.

- Restart : Restarts the system.
- Factory default : Resets the system settings to the factory defaults with following two options:
  - Except network parameter : Resets all settings except for the Network Parameters.
  - All : Restores all settings to the default.  
Initializes to the factory defaults, which functions the same to that of pressing the **[RESET]** button inside the main unit.





- After the system is reset or restarts, you should try to connect to the camera again.
- It takes several minutes until the system completes rebooting. Wait until the system rebooting is completed and try to connect again.
- After executing <Factory default>, you must run the <IP Installer.exe> program to change the basic network settings such as IP address, Subnet mask, Gateway, etc., before you can connect to the Internet.

## To set the HTTPS

1. Select <System> - <HTTPS>.

The HTTPS setup window appears.

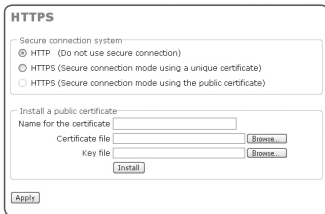

- Secure connection system : Select a secure connection system to use. To use the secure connection mode requiring the public certificate for the secure connection system, you must have installed a signed certificate issued by a certificate authority on your system.

- Install a public certificate : To install the certificate to camera, you need to type a certificate name (it can be arbitrarily assigned by user), certificate file issued from the authority and a key file. When done, click [Install].

If the certificate is installed successfully, the user-defined certificate name will be displayed. Also, the option button of <HTTPS (Secure connection mode using the public certificate)> in the upper side becomes activated.



- To access the camera using HTTPS mode, you have to type the IP address for the camera in the form of "https://<Camera\_IP>".

2. When done, click [Apply].

The web viewer will switch to the set secure connection system.

## To Set IP Filtering

1. Click <System> - <IP filtering>.

The IP Filtering Setup screen appears.

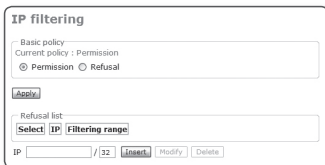

- Basic policy : You can select the IP filtering policy.

If you set to Permission, the web server allows all attempting IP addresses except the addresses added in the refusal list.

If you set to Refusal, the web server allows only IP addresses added in the permitted list and rejects all other IP addresses.

To apply the IP filtering policy, click [Apply] button.

2. Enter the IP address and subnet mask into the IP field to be allowed or rejected. The Filtering range\* will differ depending on specified IP address and subnet mask.

## OVERLAY SETUP

---

You can display text on the screen.

### To set the text

1. Select <Overlay> - <Overlay text>.

The Overlay Text setup window appears.

2. When done, click [Apply].

Your settings will be saved.

- Overlay text settings : If you select <Disable>, the overlay text will not be displayed; If selecting <Enable>, it will display on the screen.
- Show date : Set to display the date information on the bottom screen.
  - Output Format : Select a display format of the date information.  
YYYY-MM-DD : Year-Month- Day / MM-DD-YYYY : Month-Day-Year/  
DD-MM-YYYY : Day-Month-Year
- Show time : Set to display the time information on the bottom screen.
  - Output Format : Select a display format of the time information.  
24hr : Displays the time in the 24-hour format.  
12hr : Displays the time in the 12-hour format.
- Text color : Select black or white for the text color.
- Background color : Select black or white for the background color.





# EVENT SETUP

## To set the event transfer function

You can set the FTP/email server (SMTP) to transfer the alarm images present in the camera, in case an alarm event occurs.

Select <Event> - <Transfer setup>.

The Image transfer setup window appears.



- For more information on commercial SMTP services, contact the SMTP service provider.

The screenshot shows the 'Transfer setup' window with two sections:

- FTP transfer (Not verified):** Includes a checked 'Use passive mode' checkbox, and input fields for 'FTP server address', 'Upload path /', 'Port 21', 'User ID', and 'Password'. A 'Test' button is at the bottom.
- E-mail(SMTP) transfer (Not verified):** Includes a checked 'Use SSL/TLS' checkbox, and input fields for 'SMTP server address', 'Port 25', 'User ID', 'Password', 'E-mail sender', 'E-mail receiver', and 'Title'. A 'Message' text area is at the bottom, followed by a 'Test' button.

## To test the FTP transfer

Click [Test].

This will test if the image is transferred to the specified FTP server properly.

When the test on the FTP server connection and transfer is done, a message of <( Verified )> will be displayed.

You will see an error message if the test fails. If this is the case, check the FTP server status or the settings again.

This screenshot shows only the 'FTP transfer' section of the 'Transfer setup' window, which is identical to the one in the previous screenshot.

- FTP transfer :** With this, you can transfer alarm images to the FTP server. If the initial FTP server setting and the connection status are not verified, the <( Not verified )> message appears.
  - Use passive mode : Select this option when the passive mode connection is inevitable due to the firewall or FTP server setting.
  - FTP server address : Enter the IP address of a FTP server to which an alarm image will be transferred.
  - Upload path : You can specify the path of the FTP directory to which you will transfer an alarm image.  
You can specify the path by just typing </directory name> or <directory name> in this field.  
If nothing is specified, the path will be defaulted to the root directory of the FTP server.

# setup screen

---

- Port : The FTP port is defaulted to 21. This value can be changed according to the FTP server setting.
- User ID : Provide the user account ID to access the FTP server.
- Password : Provide the user account password to access the FTP server.
- **E-mail(SMTP) transfer** : With this setting, you can transfer alarm images to the email server. This function is available only for the SMTP email server. When the initial SMTP server setting and connection are not verified, the **<Not verified>** message appears.
  - SMTP server address : Enter the SMTP server address to use when you send an email.  
ex) 10.240.56.228
  - Port : Enter a port number to use when you send an email. The default is 25.
  - User ID : Provide the user account ID to access the SMTP server.
  - Password : Provide the user account password to access the SMTP server.
  - E-mail sender : Enter the address of the email sender. If the sender address is incorrect, the email from the sender may be classified as SPAM by the SMTP server and may not be sent.
  - E-mail receiver : Enter the address of the email receiver.
  - Title : Enter the subject of the email to send.
  - Message : Enter the content of the email to send.

## To test the email transfer

Click **[Test]**.

This will test if the image is transferred to the specified SMTP server properly. When the test on the SMTP server connection and transfer is done, a message of **<( Verified )>** will be displayed.

You will see an error message if the test fails.

If this is the case, check the SMTP server status or the settings again.

E-mail(SMTP) transfer  
(Not verified)

Use SSL/TLS

SMTP server address

Port 25

User ID

Password

E-mail sender

E-mail receiver

Title

Message

## To setup the record

1. Click **<Event>** - **<Record setup>**.  
The Record setup window appears.

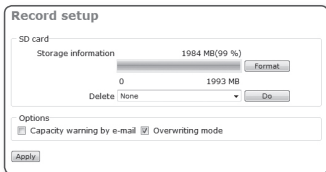

2. To complete the setting, click the **[Apply]** button.

The settings are saved.

- **SD card** : Enables you to verify data saved on the SD memory card and format the memory card itself. It is possible to set to automatically delete movie clips recorded before a certain period of time (e.g. 1 week, 1 month, or 1 year).
- **Options** : Determine whether or not you wish to receive Email notification of insufficient capacity warnings.

## To set an alarm image

You can configure to send message via FTP/E-mail (SMTP) or to save recording into the SD memory card.

Select a transfer method when an event occurs or the schedule transfer function is activated.

1. Select **<Event>** - **<Alarm image>**.

The Alarm Image setup window appears.

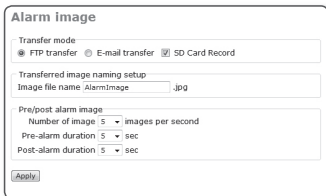

- **Transfer mode** : You can select alarm message notification method among FTP/E-mail transfer and SD Card recording.

- FTP transfer : The image is sent to the specified FTP address.
- E-mail transfer : The image is sent to the specified email address.
- SD Card Record : Saves images into the SD memory card.



- If an SD memory card is not inserted, the corresponding button will be disabled. In this case, insert the SD memory card into the slot and refresh to enable the button.



- If the SD memory card is ejected while the button is checked, the camera automatically restarts.

- **Transferred image naming setup** : You can set the file name of an alarm image to be sent when an alarm is triggered or during the scheduled transfer.
- **Pre/post alarm image** : You can set to save the pre or post alarm image.
  - Number of image : The frame rate per second can be one among 1, 2, 3, and 5.
  - Pre-alarm duration : The pre alarm duration can be one among 5 seconds, 10 seconds, 15 seconds, and 30 seconds. You can send a pre-alarm image of up to 30 seconds before the alarm is triggered. (The max time differs, depending on the frame rate)

# setup screen

- Post-alarm duration : The post alarm duration can be one among 5 seconds, 10 seconds, 15 seconds, and 30 seconds. You can send a post-alarm image of up to 30 seconds after the alarm is triggered.  
(The max time differs, depending on the frame rate)



- The pre/post alarm duration is not available in SMTP transfer mode.  
Only one image at the corresponding time will be transferred.

2. When done, click **[Apply]**.  
Your settings will be saved.

## To set the alarm input

1. Select **<Event>** - **<Alarm input 1 >** or **<Alarm input 2 >**.  
The Alarm Input setup window appears.

2. When done, click **[Apply]**.  
Your settings will be saved.

- **Input device setup** : Select an input type according to the characteristics of the alarm sensor installed in the main unit.

- Off : Turns off the alarm input setting.
- NO (Normal Open) : It is normally open, but if it is closed, an alarm will be triggered.
- NC (Normal Close) : It is normally closed, but if it is open, an alarm will be triggered.

- **Activation time** : You can set a time to execute a specific command when an alarm occurs.

- Always : Always executes the specified command when an alarm occurs.
- Only scheduled time : Activates notification as configured only when alarm events occurred during the specified time period.

- **Action** : You can set an action to execute when an alarm occurs.

- Alarm output : Set the alarm output port to which the alarm signal is transferred.
- Output duration : Set the period of time to output the alarm signal to the specified alarm output port when an alarm occurs.  
If a new alarm event is detected during the alarm output, the delay time is recalculated based on the detection time of the recent alarm.

- Alarm image transfer : If you select **<On>**, you can transfer JPEG images to a registered address via FTP or SMTP server or save images into the SD memory card according to the setting in **<Event>** - **<Transfer setup>**.

**Alarm input 1**

Input device setup  
 Off  NO  NC

Activation time  
 Always  Only scheduled time

Sun  Mon  Tue  Wed  Thu  Fri  Sat

Start time [ 9 ] : [ 0 ] End time [ 8 ] : [ 59 ]

Action  
Alarm output [ None ]  
Output duration [ 3 sec ]  
Alarm image transfer [ Off ]

[Apply]

## To Set Intelligent Video Analysis

### 1. Click <Event> - <Intelligent video analysis>.

The Intelligent Video Analysis screen appears.

### 2. When done, click [Apply].

Your settings will be saved.

- **IV analysis function** : Activated if <Enable> is selected, deactivated if <Disable> is selected.



- If camera is capturing a close object, the video analysis capability may degrade.



- In the following cases, the video analysis function may not produce proper result on configured event and motion detections.
  - The subject color or brightness is similar to the background
  - Multiple random movement continues due to scene change or other reasons.
  - When object that is fixed continues to move in the same position.
  - An object hides other objects behind.
  - 2 or more objects overlaps or 1 object splits into multiple objects.
  - Too fast object (for detection, one object should be found overlapping between contiguous frames).
  - Reflection / blur / shadow due to direct sunlight, illumination, or headlamp
  - In severe snow, rain, wind or in dawn / dusk
  - Moving object approaches to the camera too close

- **Overlay** : If <Enable> is selected, configured event rules and motion frame are displayed on the Live screen. Selecting <Disable> will not display overlay information.



- Motion frame is displayed in two types on the Live screen.
  - Green frame – indicates the moving object
  - Red frame – Temporarily displays the moving object detected by the configured event rules.

- **Sensitivity** : Sets the sensitivity of the intelligent video analysis.
  - Sensitivity : Select the sensitivity among <Very high>, <High>, <Normal>, <Low>, and <Very low>.
  - When selected with <Very high>, the intelligent video analysis functions on the smallest motion detection.

**Intelligent video analysis**

IV analysis function  
 Enable  Disable

Overlay  
 Enable  Disable

Sensitivity  
Sensitivity | Very low

Set rules  
Virtual line based rules  
 →  
 ←  
 ↔

Activation time  
 Always  Only scheduled time  
 Sun  Mon  Tue  Wed  Thu  Fri  Sat  
Start time 9 : 0 End time 8 : 59

Action  
Alarm output | None  
Output duration | 3 sec  
Alarm image transfer | Off

[Apply]

# setup screen

---

- **Set rules**

You can set the event rules.

- Virtual line based rules : You can configure event rules for up to 3 virtual lines.

<Event Types>

Pass : Event is generated if a moving object crosses the virtual line in the specified direction (←, →, ↔)

- Defined area based rules : You can configure event rules for up to 3 user-defined areas.

<Event Types>

① Entering : Event is generated if a moving object enters the defined area from outside to inside.

② Exiting : Event is generated if a moving object exits the defined area from inside to outside.

③ Appearing : An object that has not been existed in the area until the previous frame suddenly appears inside the configured area, not passing the border

④ Disappearing : An object that has been existed in the area until the previous frame suddenly disappears, not passing the border.

- Entire area based rules : You can configure event rules for the entire video area.

<Event Types>

① Appearing: An object that has not been existed until the previous frame appears in the area.

② Disappearing: An object that has been existed until the previous frame disappears from the area.

③ Scene Change: This event is generated by a complete scene change, such as camera veiled by hand or changed camera's aiming, etc.

- Object size: The maximum rectangular motion detection area for each event generation. The minimum size can be adjusted in 5 levels.

Minimum size (the minimum rectangular motion detection area): Step 1: 6x6 (pixel), Step 5: 50x50 (pixel)

Maximum size (the maximum rectangular motion detection area): Step 1: 60x60 (pixel), Step 5: 320x240 (pixel)

The initial setup for the minimum is 6x6 and for the maximum is 320x240.

- **Activation time** : Sets the operation time of the intelligent video analysis.
  - Always : Configured action is performed whenever an intelligent video analysis event occurs.
  - Only scheduled time : Configured action is performed when intelligent video analysis event occurs during the specified time period.
- **Action** : You can configure the action for an intelligent video analysis event.
  - Alarm output : Sets the alarm output port for the signaling the intelligent video analysis event.
  - Output duration : Sets the alarm signal dwell time to the Alarm Output port on an intelligent video analysis event.  
When another intelligent video analysis event follows the previous one, the output duration time is reset based on the most recent event.
  - Alarm image transfer : If selected <Enable>, depending on your setting of <Event> - <Transfer setup>, the image in JPEG format will be sent to the registered address via FTP or e-mail (SMTP), or saved in the SD memory card.

## To set the scheduled transfer

You can set to transfer the JPEG image to the FTP/SMTP server saved in the SD memory card at a specific interval.

### 1. Select <Event> - <Schedule>.

The Schedule Transfer setup window appears.

#### ● **Schedule transfer function** :

If selecting <Enable>, the schedule transfer function will be activated; if selecting <Disable>, it will be deactivated.

#### ● **Transfer interval** : You can set the time interval to transfer images.

You can set the unit of the interval to <seconds> or <minutes>; you can also set to transfer one image per 5/15/30/45/60 seconds, or one per 5/15/30/45/60 minutes.

#### ● **Activation time** : You can set a time to execute a specific command when a schedule transfer event occurs.

- Always : Always sends an image at the set interval.
- Only scheduled time : Periodically transfers image only during the specified time period.

### 2. When done, click [Apply].

Your settings will be saved.

## NETWORK SETUP

### To set the video transfer mode

You can control the transfer rate according to the video transfer mode and network speed.

1. Select **<Network>** - **<Streaming type>**.

The Video Transfer setup window appears.

2. When done, click **[Apply]**.

Your settings will be saved.

- **VNP streaming** : You can set the Samsung Protocol (VNP) for the streaming service.
  - Protocol : Select a video transfer protocol from TCP\*, UDP (Unicast)\*, and UDP (Multicast)\*.
    - Speaking to the camera unit through microphone is not supported.
    - Multicast backbone (Mbone) is not supported; you can access the camera only in the multicast local network environment.
- **RTP streaming** : You can set the RTP Protocol or the streaming service.
  - Protocol : Select a video transfer protocol from UDP (Unicast) and UDP (Multicast).

Streaming type

VNP streaming  
Protocol TCP

RTP streaming  
Protocol UDP (Unicast)

Apply

### To set the DDNS

DDNS is an abbreviation of Dynamic Domain Name Service that converts the IP address of a camera into a general Host Name so that the user can easily remember it and enables connecting a camera with a fixed Host Name even if the IP address of the camera may be dynamically changed.

1. Select **<Network>** - **<DDNS>**.

The DDNS setup window appears.

2. When done, click **[Apply]**.

Your settings will be saved.

DDNS

DDNS setup  
( 211.219.138.115 )

Disable

Samsung DDNS

Host name m47205a.websamsung.net

Public DDNS

Select a DDNS service www.no-ip.com

Host name

User name

Password

Apply



- For checking the DDNS address, refer to "To check the DDNS address". (page 48)



## PROFILE

CAMERA SETUP MENU		STANDARD	ITS	BACKLIGHT	DAY/NIGHT	GAMING
Parent Menu	Sub-menus					
IRIS		ALC	ALC	ALC	ALC	ALC
	ALC	-	-	-	-	-
	LENS	DC	DC	DC	DC	DC
	LEVEL	0	0	0	0	0
	BACKLIGHT	OFF	OFF	WDR	OFF	OFF
MOTION		(F.FAST) ---	(F.FAST) ---	NORM	(F.FAST) ---	SLOW
DNR		MID	MID	MID	MID	MID
SHUTTER		OFF	AUTO 1/250	OFF	OFF	OFF
SENSE UP		AUTO X4	AUTO X2	AUTO X4	AUTO X4	AUTO X4
XDR		MID	MID	MID	MID	MID
DAY/NIGHT		AUTO	AUTO	DAY	AUTO	DAY
	NIGHT	-	-	-	-	-
	BURST	OFF	ON	OFF	OFF	OFF
WHITE BAL		DAY	DAY/NIGHT	DAY	DAY/NIGHT	DAY
	DAY	-	-	-	-	-
	MODE	ATW2	ATW1	ATW1	ATW1	ATW1
	RED	0	0	0	0	0
	BLUE	0	0	0	0	0
	NIGHT	-	-	-	-	-
	BRIGHTNESS	Custom Setting	MID	Custom Setting	MID	Custom Setting
	MODE	OFF	ATW2	OFF	ATW2	OFF
	RED	Custom Setting	0	Custom Setting	0	Custom Setting
	BLUE	Custom Setting	0	Custom Setting	0	Custom Setting
DETAIL		2	2	2	2	2

## TERMINOLOGY

---

- **GOP** : You can set between 5 and 15 for the MPEG4 and H.264 CODEC.  
The default is 15, and if set to 15, one I-Frame will be output per 15 frames as one I-Frame and 14 P-Frames constitute the GOP.  
The lower the GOP size is, the better the quality is; however, the bit rate as well as the data size will increase, causing a lower of the fps. GOP(Group of Pictures) is a set of video frames for MPEG4 and H.264 format compression, indicating a collection of frames from the initial I-Frame (key frame) to the next I-Frame. GOP consists of 2 kinds of frames: I-Frame and P-Frame. I-Frame is the basic frame for the compression, also known as Key Frame, which contains one complete image data. P-Frame contains only the data that has changed from the preceding I-Frame.
- **Entropy coding** : Data transfer technology used to reduce the compression loss from encoding.
  - **CAVLC** (Context-adaptive variable-length coding): Records a higher compression loss rate than CABAC.
  - **CABAC** (Context-adaptive binary arithmetic coding): Shows a lesser compression loss than CAVLC.
- **Bitrate Control**
  - **CBR**(Constant Bitrate)  
This will transfer video data in an equal size at all times, regardless of the video complexity. The video quality may be deteriorated, depending on the video complexity.
  - **VBR**(Variable Bitrate)  
The amount of video data to transfer may differ, depending on the video complexity. This enables receiving video data in an equal quality at all times.
- **TTL** : TTL stands for "Time To Live", which you can specify to prevent loss of data packet that passes through multiple-staged routers. Each router decreases the TTL value by one each time a packet passes it through; If the TTL value reaches 0, the packet cannot further pass through a router.
- **TCP** : It is a general purpose protocol used for transmission that requires reliability. With constant communication between the sender and recipient, it provides high reliability against transmission data loss; however, it has imitation to transmit a large amount of data in real time at a high speed.  
It enables reliable data transmission over xDSL and cable network at a relatively slow speed.
- **UDP (Unicast)**: It refers to a system that transmits data between only one transmitter and one receiver (1:1).
- **UDP (Multicast)**: It refers to the data transfer protocol in one-to-many (1:N) between the transmitting and receiving terminals; although it alleviates the network load, it requires <Multicast> router.  
For more information such as whether the network over which the camera is installed supports <Multicast>, contact the network administrator.
- **UDP** : It is a protocol appropriate to transmit a large amount of data such as multimedia data at a high speed. However, with its nonconnection structure, it records a higher transmission efficiency than TCP especially in a high LAN environment faster than 100Mbps.

- Filtering range

The filtering range is calculated based on IP address and subnet mask provided by user as follows:

The subnet value defines the number of masked bits, which will mask the IP address that is converted into 32-bit binary; rest of masked out bits are ignored to produce the range as shown below.

Ex) IP address : 128.128.128.128

- ① If the Subnet is set to 8, converted IP is 1000 0000.1000 0000.1000 0000.1000 0000 and the subnet directs to find matches from the first bit to the 8th bit, produces the filtering range of 1000 0000.???? ?????.???? ?????.???? ?????, which will be converted back to IP address range of 128.0.0.0 ~ 128.255.255.255.
- ② If the Subnet is set to 10, converted IP is 1000 0000.1000 0000.1000 0000.1000 0000 and the subnet directs to find matches from the first bit to the 10th bit, produces the filtering range of 1000 0000.0000.10?? ?????.???? ?????.???? ?????, which will be converted back to IP address range of 128.0.0.0 ~ 128.191.255.255.
- ③ If the Subnet is set to 20, converted IP is 1000 0000.1000 0000.1000 0000.1000 0000 and the subnet directs to find matches from the first bit to the 20th bit, produces the filtering range of 1000 00001000 0000.1000 ?????.???? ?????, which will be converted back to IP address range of 128.128.128.0 ~ 128.128.143.255.
- ④ If the Subnet is set to 30, converted IP is 1000 0000.1000 0000.1000 0000.1000 0000 and the subnet directs to find matches from the first bit to the 30th bit, produces the filtering range of 1000 0000.1000 0000.1000 0000.1000 00??, which will be converted back to IP address range of 128.128.128.128 ~ 128.128.128.131.
- ⑤ If the Subnet is set to 32, converted IP is 1000 0000.1000 0000.1000 0000.1000 0000 and the subnet directs to find matches from the first bit to the 32th bit, produces the filtering range of 1000 0000.1000 0000.1000 0000.1000 0000, which will be converted back to IP address of 128.128.128.128.

## SPECIFICATIONS

Item			Description	
			NTSC	PAL
Camera Type	Color/BW		Color	
Image	Device		1/3" Super-HAD PS CCD	
	Pixels	Total	811 x 508	795 x 596
		Effective	768 x 494	752 x 582
Scanning	System		Progressive	
	Horizontal Frequency		15.734 Hz	15.625 Hz
	Vertical Frequency		59.94 Hz	50 Hz
Min. Scene Illumination	Color		Sens off : 0.12 Lux(15 IRE), 0.2 Lux(30 IRE), 0.4Lux(50 IRE)@F1.2 Sens up x512 : 0.00023 Lux(15 IRE), 0.0005 Lux(30 IRE), 0.0008Lux(50 IRE)@F1.2	
	B/W		Sens off : 0.012 Lux(15 IRE), 0.02 Lux(30 IRE), 0.04Lux(50 IRE)@F1.2 Sens up x512 : 0.000023 Lux(15 IRE), 0.00005 Lux(30 IRE), 0.00008Lux(50 IRE)@F1.2	
Functions	Number of Privacy Zone		12 ea	
	Day/Night		Day/Night/AUTO(Hard Method)	
	WDR		Off/On (x128)	
	Extended Dynamic Range		Off/On (Level Setting)	
	D-Zoom		x1 ~ x16 (x0.1 STEP)	
	PIP		Off/On (Advanced)	
	High Speed Shutter		1/60 ~ 1/10Ksec	1/50 ~ 1/10Ksec
	Flickerless		Off/On	
	Sens Up		x2 ~ x512	
	BLC		Off/On (Area Setting)	
	AGC		Off/On (Max.Level Setting)	
	Camera ID		Off/On (Max.54ea/2Line)	
	White Balance		ATW1/ATW2/AWC/3200K/5600K	
	Digital Noise Reduction		Off/On (Adaptive 3D+2D)	
Digital Image Stabilization		Off/On		
Etc. Function		Detail, Reverse(H/V), Posi/Nega		

Item		Description		
		NTSC	PAL	
Resolution	Horizontal	600 TV Lines		
	Vertical	350 TV Lines		
Video Output	Video Output	VBS 1.0Vp-p		
S/N Ratio	S/N Ratio	about 52 dB		
Lens	Lens Drive Type	MANUAL/AI(VIDEO/DC)		
	Mount Type	CS/C		
Network Board	OS	Embedded Linux		
	Hardware	Flash memory	32M byte	
		RAM	256M byte	
		DSP	TI Davinci	
		Ethernet	RJ-45 (10/100BASE-T)	
PoE	Yes (IEEE802.3af)			
Alarm	Input	2 ea		
	Output	2 ea		
Video	Compression	H.264 / MPEG4 / MJPEG Multiple Codec (H.264 / MPEG4 selectable) Simultaneous Dual Streaming		
	Resolution	4CIF	704x480	704x576
		VGA	640x480	
		CIF	352x240	352x288
	Frame Rate	30, 15, 8, 3, 1 fps	25, 13, 6, 3, 1 fps	
Quality	1 ~ 10 level			
Audio	Compression	Full Duplex, 64kbps, 8KHz sampling		
OSD	Camera Control and Adjustment	OSD menu on Video (Menu enter/exit, move by Web UI) * Some key adjustment menus will be supported by CGI API.		
Intelligent Video Analysis Detection	Sensitivity	Very High, High, Normal, Low, Very Low		

# appendix

Item			Description	
			NTSC	PAL
Protocol	IP		IPv4 / IPv6	
	Network Protocol	IPv4	TCP/IP, UDP/IP, RTP(UDP), RTP(TCP), RTSP, NTP, HTTP, HTTPS, SSL, DHCP PPPoE, FTP, SMTP, ICMP, IGMP, SNMPv1/v2c/v3(MIB-2), ARP, DNS, DDNS, VSIP	
		IPv6	TCP/IP, HTTP, HTTPS, SSL, DHCP	
	Streaming		Unicast (TCP, UDP), Multicast (UDP)	
	Security		HTTPS Login Authentication Digest Login Authentication	
	DDNS		Supporting Samsung DDNS and Public DDNS services	
Connection	Maximum User Access		Max 10 Users at Unicast (TCP, UDP) Mode Max 20 Users at Multicast (UDP) Mode	
	User Access Level	Administrator	Live Monitoring, Alarm I/O control, OSD menu control, SETUP	
		Operator	Live Monitoring, Alarm I/O control	
		User	Live Monitoring	
Event Management	Alarm Input		JPEG Image transfer : FTP, SMTP, SD Card	
	Intelligent Video Analysis Detection		Notification : notify to viewer or by E-mail (one image attachment) Alarm Out	
	Schedule		JPEG Image transfer : FTP, SMTP, SD Card	
Web Browser Viewer (Default)	Supported OS		Windows XP, VISTA	
	Supported Browser		Internet Explorer 6.0 or Higher	
	UI Language		E/F/G/S/I/C/K	
	S/W upgrade		Support	
Video Player	RTP/RTSP streaming		Quicktime, VLC player	
Video Management Software	Video Management System		Samsung NET-i 3rd Party S/W application	
Application	IP Installation		IP Installer Application for All Samsung IP Devices	

Item			Description	
			NTSC	PAL
SDK	HTTP API	CGI Command	Provides functionality to control cameras and set/retrieve internal parameter values. Get JPEG image or MJPEG stream Alarm In/Out control	
	RTP/RTSP API		RTP Header, RTSP Command Document	
	ActiveX	SDK	ActiveX API for viewing data streams from IP camera.	
Power			AC24V±10%(60Hz±0.3Hz)/ DC12V+10%/-5% / PoE (Power over Ethernet)	
Power Consumption			About 8W (Heater OFF), About 11W (Heater ON)	
Operating Temp.			-10°C~50°C	
Operating Humidity			~90%	
Dimension			W160 X D160 X H134.5	
Weight			About 1220g	

## FRAME RATE (NTSC)



- Test Condition: MJPEG - Resolution(CIF), Quality(1), Frame rate(1)  
 H.264 - Bitrate control(CBR), Compression(40), Encode Priority(Frame rate),  
 GOP size(15), Deblock(ON), Profile(Baseline), Entropy coding(CAVLC), Motion  
 estimation(HPEI)  
 MPEG4 - Bitrate control(CBR), Compression(40), Encode Priority(Frame rate),  
 GOP size(15)

### ❖ MPEG4 (4CIF)

Quality \ Frame Rate	30 FPS	15 FPS	8 FPS	3 FPS	1 FPS
LEVEL10	4239 Kbps 23 FPS	2765 Kbps 15 FPS	1290 Kbps 7 FPS	737 Kbps 4 FPS	221 Kbps 1 FPS
LEVEL9	3686 Kbps 24 FPS	2304 Kbps 15 FPS	1075 Kbps 7 FPS	614 Kbps 4 FPS	184 Kbps 1 FPS
LEVEL8	3072 Kbps 25 FPS	1843 Kbps 15 FPS	860 Kbps 7 FPS	492 Kbps 4 FPS	147 Kbps 1 FPS
LEVEL7	2396 Kbps 26 FPS	1382 Kbps 15 FPS	645 Kbps 7 FPS	369 Kbps 4 FPS	111 Kbps 1 FPS
LEVEL6	1659 Kbps 27 FPS	922 Kbps 15 FPS	430 Kbps 7 FPS	246 Kbps 4 FPS	74 Kbps 1 FPS
LEVEL5	1336 Kbps 29 FPS	691 Kbps 15 FPS	323 Kbps 7 FPS	184 Kbps 4 FPS	55 Kbps 1 FPS
LEVEL4	1133 Kbps 30 FPS	576 Kbps 15 FPS	269 Kbps 7 FPS	154 Kbps 4 FPS	46 Kbps 1 FPS
LEVEL3	922 Kbps 30 FPS	461 Kbps 15 FPS	215 Kbps 7 FPS	123 Kbps 4 FPS	37 Kbps 1 FPS
LEVEL2	691 Kbps 30 FPS	346 Kbps 15 FPS	161 Kbps 7 FPS	92 Kbps 4 FPS	28 Kbps 1 FPS
LEVEL1	461 Kbps 30 FPS	230 Kbps 15 FPS	108 Kbps 7 FPS	61 Kbps 4 FPS	18 Kbps 1 FPS



## ❖ H.264 (4CIF)

Frame Rate Quality	30 FPS	15 FPS	8 FPS	3 FPS	1 FPS
LEVEL10	2298 Kbps 19 FPS	1229 Kbps 10 FPS	737 Kbps 6 FPS	369 Kbps 3 FPS	147 Kbps 1 FPS
LEVEL9	1751 Kbps 19 FPS	1198 Kbps 13 FPS	645 Kbps 7 FPS	369 Kbps 4 FPS	111 Kbps 1 FPS
LEVEL8	1536 Kbps 20 FPS	1075 Kbps 14 FPS	538 Kbps 7 FPS	307 Kbps 4 FPS	92 Kbps 1 FPS
LEVEL7	1352 Kbps 22 FPS	897 Kbps 15 FPS	430 Kbps 7 FPS	246 Kbps 4 FPS	74 Kbps 1 FPS
LEVEL6	1129 Kbps 25 FPS	691 Kbps 15 FPS	369 Kbps 8 FPS	184 Kbps 4 FPS	55 Kbps 1 FPS
LEVEL5	960 Kbps 25 FPS	576 Kbps 15 FPS	307 Kbps 8 FPS	154 Kbps 4 FPS	46 Kbps 1 FPS
LEVEL4	799 Kbps 26 FPS	461 Kbps 15 FPS	246 Kbps 8 FPS	123 Kbps 4 FPS	37 Kbps 1 FPS
LEVEL3	622 Kbps 27 FPS	346 Kbps 15 FPS	184 Kbps 8 FPS	92 Kbps 4 FPS	28 Kbps 1 FPS
LEVEL2	445 Kbps 29 FPS	230 Kbps 15 FPS	123 Kbps 8 FPS	61 Kbps 4 FPS	18 Kbps 1 FPS
LEVEL1	223 Kbps 29 FPS	115 Kbps 15 FPS	61 Kbps 8 FPS	31 Kbps 4 FPS	9 Kbps 1 FPS

## ❖ MPEG4 (VGA)

Quality \ Frame Rate	30 FPS	15 FPS	8 FPS	3 FPS	1 FPS
LEVEL10	4055 Kbps 22 FPS	2580 Kbps 14 FPS	1290 Kbps 7 FPS	737 Kbps 4 FPS	221 Kbps 1 FPS
LEVEL9	3533 Kbps 23 FPS	2304 Kbps 15 FPS	1075 Kbps 7 FPS	614 Kbps 4 FPS	184 Kbps 1 FPS
LEVEL8	2949 Kbps 24 FPS	1843 Kbps 15 FPS	860 Kbps 7 FPS	492 Kbps 4 FPS	147 Kbps 1 FPS
LEVEL7	2304 Kbps 25 FPS	1382 Kbps 15 FPS	645 Kbps 7 FPS	369 Kbps 4 FPS	111 Kbps 1 FPS
LEVEL6	1536 Kbps 25 FPS	922 Kbps 15 FPS	430 Kbps 7 FPS	246 Kbps 4 FPS	74 Kbps 1 FPS
LEVEL5	1152 Kbps 25 FPS	691 Kbps 15 FPS	323 Kbps 7 FPS	184 Kbps 4 FPS	55 Kbps 1 FPS
LEVEL4	998 Kbps 26 FPS	576 Kbps 15 FPS	269 Kbps 7 FPS	154 Kbps 4 FPS	46 Kbps 1 FPS
LEVEL3	799 Kbps 26 FPS	461 Kbps 15 FPS	246 Kbps 8 FPS	123 Kbps 4 FPS	37 Kbps 1 FPS
LEVEL2	622 Kbps 27 FPS	346 Kbps 15 FPS	184 Kbps 8 FPS	92 Kbps 4 FPS	28 Kbps 1 FPS
LEVEL1	415 Kbps 27 FPS	230 Kbps 15 FPS	123 Kbps 8 FPS	61 Kbps 4 FPS	18 Kbps 1 FPS

## ❖ H.264 (VGA)

Frame Rate Quality	30 FPS	15 FPS	8 FPS	3 FPS	1 FPS
LEVEL10	2089 Kbps 17 FPS	1229 Kbps 10 FPS	737 Kbps 6 FPS	369 Kbps 3 FPS	147 Kbps 1 FPS
LEVEL9	1659 Kbps 18 FPS	1014 Kbps 11 FPS	553 Kbps 6 FPS	276 Kbps 3 FPS	111 Kbps 1 FPS
LEVEL8	1459 Kbps 19 FPS	845 Kbps 11 FPS	538 Kbps 7 FPS	307 Kbps 4 FPS	92 Kbps 1 FPS
LEVEL7	1229 Kbps 20 FPS	737 Kbps 12 FPS	430 Kbps 7 FPS	246 Kbps 4 FPS	74 Kbps 1 FPS
LEVEL6	1014 Kbps 22 FPS	691 Kbps 15 FPS	323 Kbps 7 FPS	184 Kbps 4 FPS	55 Kbps 1 FPS
LEVEL5	883 Kbps 23 FPS	576 Kbps 15 FPS	269 Kbps 7 FPS	154 Kbps 4 FPS	46 Kbps 1 FPS
LEVEL4	707 Kbps 23 FPS	461 Kbps 15 FPS	215 Kbps 7 FPS	123 Kbps 4 FPS	37 Kbps 1 FPS
LEVEL3	553 Kbps 24 FPS	346 Kbps 15 FPS	161 Kbps 7 FPS	92 Kbps 4 FPS	28 Kbps 1 FPS
LEVEL2	384 Kbps 25 FPS	230 Kbps 15 FPS	108 Kbps 7 FPS	61 Kbps 4 FPS	18 Kbps 1 FPS
LEVEL1	200 Kbps 26 FPS	115 Kbps 15 FPS	54 Kbps 7 FPS	31 Kbps 4 FPS	9 Kbps 1 FPS

# appendix

---

## ❖ MPEG4 (CIF)

Quality \ Frame Rate	30 FPS	15 FPS	8 FPS	3 FPS	1 FPS
LEVEL10	1382 Kbps 30 FPS	691 Kbps 15 FPS	369 Kbps 8 FPS	184 Kbps 4 FPS	55 Kbps 1 FPS
LEVEL9	1152 Kbps 30 FPS	576 Kbps 15 FPS	307 Kbps 8 FPS	154 Kbps 4 FPS	46 Kbps 1 FPS
LEVEL8	922 Kbps 30 FPS	461 Kbps 15 FPS	246 Kbps 8 FPS	123 Kbps 4 FPS	37 Kbps 1 FPS
LEVEL7	691 Kbps 30 FPS	346 Kbps 15 FPS	184 Kbps 8 FPS	92 Kbps 4 FPS	28 Kbps 1 FPS
LEVEL6	461 Kbps 30 FPS	230 Kbps 15 FPS	123 Kbps 8 FPS	61 Kbps 4 FPS	18 Kbps 1 FPS
LEVEL5	346 Kbps 30 FPS	173 Kbps 15 FPS	92 Kbps 8 FPS	46 Kbps 4 FPS	14 Kbps 1 FPS
LEVEL4	288 Kbps 30 FPS	144 Kbps 15 FPS	77 Kbps 8 FPS	38 Kbps 4 FPS	12 Kbps 1 FPS
LEVEL3	230 Kbps 30 FPS	115 Kbps 15 FPS	61 Kbps 8 FPS	31 Kbps 4 FPS	9 Kbps 1 FPS
LEVEL2	173 Kbps 30 FPS	86 Kbps 15 FPS	46 Kbps 8 FPS	23 Kbps 4 FPS	7 Kbps 1 FPS
LEVEL1	151 Kbps 30 FPS	76 Kbps 15 FPS	40 Kbps 8 FPS	20 Kbps 4 FPS	6 Kbps 1 FPS

## ❖ H.264 (CIF)

Quality \ Frame Rate	30 FPS	15 FPS	8 FPS	3 FPS	1 FPS
LEVEL10	922 Kbps 30 FPS	461 Kbps 15 FPS	215 Kbps 7 FPS	123 Kbps 4 FPS	37 Kbps 1 FPS
LEVEL9	691 Kbps 30 FPS	346 Kbps 15 FPS	184 Kbps 8 FPS	92 Kbps 4 FPS	28 Kbps 1 FPS
LEVEL8	576 Kbps 30 FPS	288 Kbps 15 FPS	134 Kbps 7 FPS	77 Kbps 4 FPS	23 Kbps 1 FPS
LEVEL7	461 Kbps 30 FPS	230 Kbps 15 FPS	108 Kbps 7 FPS	61 Kbps 4 FPS	18 Kbps 1 FPS
LEVEL6	346 Kbps 30 FPS	173 Kbps 15 FPS	81 Kbps 7 FPS	46 Kbps 4 FPS	14 Kbps 1 FPS
LEVEL5	288 Kbps 30 FPS	144 Kbps 15 FPS	67 Kbps 7 FPS	38 Kbps 4 FPS	12 Kbps 1 FPS
LEVEL4	230 Kbps 30 FPS	115 Kbps 15 FPS	54 Kbps 7 FPS	31 Kbps 4 FPS	9 Kbps 1 FPS
LEVEL3	173 Kbps 30 FPS	86 Kbps 15 FPS	40 Kbps 7 FPS	23 Kbps 4 FPS	7 Kbps 1 FPS
LEVEL2	115 Kbps 30 FPS	58 Kbps 15 FPS	27 Kbps 7 FPS	15 Kbps 4 FPS	5 Kbps 1 FPS
LEVEL1	58 Kbps 30 FPS	29 Kbps 15 FPS	13 Kbps 7 FPS	8 Kbps 4 FPS	2 Kbps 1 FPS

## FRAME RATE (PAL)



■ Test Condition: MJPEG - Resolution(CIF), Quality(1), Frame rate(1)

H.264 - Bitrate control(CBR), Compression(40), Encode Priority(Frame rate),  
GOP size(15), Deblock(ON), Profile(Baseline), Entropy coding(CAVLC), Motion  
estimation(HPEI)

MPEG4 - Bitrate control(CBR), Compression(40), Encode Priority(Frame rate),  
GOP size(15)

### ❖ MPEG4 (4CIF)

Quality \ Frame Rate	25 FPS	13 FPS	6 FPS	3 FPS	1 FPS
LEVEL10	4645 Kbps 21 FPS	2654 Kbps 12 FPS	1327 Kbps 6 FPS	664 Kbps 3 FPS	221 Kbps 1 FPS
LEVEL9	4055 Kbps 22 FPS	2212 Kbps 12 FPS	1106 Kbps 6 FPS	553 Kbps 3 FPS	184 Kbps 1 FPS
LEVEL8	3391 Kbps 23 FPS	1769 Kbps 12 FPS	885 Kbps 6 FPS	442 Kbps 3 FPS	147 Kbps 1 FPS
LEVEL7	2544 Kbps 23 FPS	1327 Kbps 12 FPS	664 Kbps 6 FPS	332 Kbps 3 FPS	111 Kbps 1 FPS
LEVEL6	1769 Kbps 24 FPS	885 Kbps 12 FPS	442 Kbps 6 FPS	221 Kbps 3 FPS	74 Kbps 1 FPS
LEVEL5	1382 Kbps 25 FPS	664 Kbps 12 FPS	332 Kbps 6 FPS	166 Kbps 3 FPS	55 Kbps 1 FPS
LEVEL4	1152 Kbps 25 FPS	553 Kbps 12 FPS	276 Kbps 6 FPS	138 Kbps 3 FPS	46 Kbps 1 FPS
LEVEL3	922 Kbps 25 FPS	442 Kbps 12 FPS	221 Kbps 6 FPS	111 Kbps 3 FPS	37 Kbps 1 FPS
LEVEL2	691 Kbps 25 FPS	332 Kbps 12 FPS	166 Kbps 6 FPS	83 Kbps 3 FPS	28 Kbps 1 FPS
LEVEL1	461 Kbps 25 FPS	221 Kbps 12 FPS	111 Kbps 6 FPS	55 Kbps 3 FPS	18 Kbps 1 FPS

## ❖ H.264 (4CIF)

Frame Rate Quality	25 FPS	13 FPS	6 FPS	3 FPS	1 FPS
LEVEL10	2359 Kbps 16 FPS	1180 Kbps 8 FPS	737 Kbps 5 FPS	442 Kbps 3 FPS	147 Kbps 1 FPS
LEVEL9	1991 Kbps 18 FPS	1106 Kbps 10 FPS	664 Kbps 6 FPS	332 Kbps 3 FPS	111 Kbps 1 FPS
LEVEL8	1751 Kbps 19 FPS	1014 Kbps 11 FPS	553 Kbps 6 FPS	276 Kbps 3 FPS	92 Kbps 1 FPS
LEVEL7	1475 Kbps 20 FPS	885 Kbps 12 FPS	442 Kbps 6 FPS	221 Kbps 3 FPS	74 Kbps 1 FPS
LEVEL6	1161 Kbps 21 FPS	664 Kbps 12 FPS	332 Kbps 6 FPS	166 Kbps 3 FPS	55 Kbps 1 FPS
LEVEL5	968 Kbps 21 FPS	553 Kbps 12 FPS	276 Kbps 6 FPS	138 Kbps 3 FPS	46 Kbps 1 FPS
LEVEL4	811 Kbps 22 FPS	442 Kbps 12 FPS	221 Kbps 6 FPS	111 Kbps 3 FPS	37 Kbps 1 FPS
LEVEL3	608 Kbps 22 FPS	332 Kbps 12 FPS	166 Kbps 6 FPS	83 Kbps 3 FPS	28 Kbps 1 FPS
LEVEL2	424 Kbps 23 FPS	221 Kbps 12 FPS	111 Kbps 6 FPS	55 Kbps 3 FPS	18 Kbps 1 FPS
LEVEL1	230 Kbps 25 FPS	111 Kbps 12 FPS	55 Kbps 6 FPS	28 Kbps 3 FPS	9 Kbps 1 FPS

## ❖ MPEG4 (VGA)

Quality \ Frame Rate	25 FPS	13 FPS	6 FPS	3 FPS	1 FPS
LEVEL10	4424 Kbps 20 FPS	2654 Kbps 12 FPS	1327 Kbps 6 FPS	664 Kbps 3 FPS	221 Kbps 1 FPS
LEVEL9	3871 Kbps 21 FPS	2212 Kbps 12 FPS	1106 Kbps 6 FPS	553 Kbps 3 FPS	184 Kbps 1 FPS
LEVEL8	3097 Kbps 21 FPS	1769 Kbps 12 FPS	885 Kbps 6 FPS	442 Kbps 3 FPS	147 Kbps 1 FPS
LEVEL7	2433 Kbps 22 FPS	1327 Kbps 12 FPS	664 Kbps 6 FPS	332 Kbps 3 FPS	111 Kbps 1 FPS
LEVEL6	1769 Kbps 24 FPS	885 Kbps 12 FPS	442 Kbps 6 FPS	221 Kbps 3 FPS	74 Kbps 1 FPS
LEVEL5	1382 Kbps 25 FPS	664 Kbps 12 FPS	332 Kbps 6 FPS	166 Kbps 3 FPS	55 Kbps 1 FPS
LEVEL4	1152 Kbps 25 FPS	553 Kbps 12 FPS	276 Kbps 6 FPS	138 Kbps 3 FPS	46 Kbps 1 FPS
LEVEL3	922 Kbps 25 FPS	442 Kbps 12 FPS	221 Kbps 6 FPS	111 Kbps 3 FPS	37 Kbps 1 FPS
LEVEL2	691 Kbps 25 FPS	332 Kbps 12 FPS	166 Kbps 6 FPS	83 Kbps 3 FPS	28 Kbps 1 FPS
LEVEL1	461 Kbps 25 FPS	221 Kbps 12 FPS	111 Kbps 6 FPS	55 Kbps 3 FPS	18 Kbps 1 FPS



## ❖ H.264 (VGA)

Frame Rate Quality	25 FPS	13 FPS	6 FPS	3 FPS	1 FPS
LEVEL10	2507 Kbps 17 FPS	1327 Kbps 9 FPS	737 Kbps 5 FPS	442 Kbps 3 FPS	147 Kbps 1 FPS
LEVEL9	1991 Kbps 18 FPS	1217 Kbps 11 FPS	664 Kbps 6 FPS	332 Kbps 3 FPS	111 Kbps 1 FPS
LEVEL8	1659 Kbps 18 FPS	1106 Kbps 12 FPS	553 Kbps 6 FPS	276 Kbps 3 FPS	92 Kbps 1 FPS
LEVEL7	1401 Kbps 19 FPS	885 Kbps 12 FPS	442 Kbps 6 FPS	221 Kbps 3 FPS	74 Kbps 1 FPS
LEVEL6	1106 Kbps 20 FPS	664 Kbps 12 FPS	332 Kbps 6 FPS	166 Kbps 3 FPS	55 Kbps 1 FPS
LEVEL5	968 Kbps 21 FPS	553 Kbps 12 FPS	276 Kbps 6 FPS	138 Kbps 3 FPS	46 Kbps 1 FPS
LEVEL4	774 Kbps 21 FPS	442 Kbps 12 FPS	221 Kbps 6 FPS	111 Kbps 3 FPS	37 Kbps 1 FPS
LEVEL3	608 Kbps 22 FPS	332 Kbps 12 FPS	166 Kbps 6 FPS	83 Kbps 3 FPS	28 Kbps 1 FPS
LEVEL2	424 Kbps 23 FPS	221 Kbps 12 FPS	111 Kbps 6 FPS	55 Kbps 3 FPS	18 Kbps 1 FPS
LEVEL1	230 Kbps 25 FPS	111 Kbps 12 FPS	55 Kbps 6 FPS	28 Kbps 3 FPS	9 Kbps 1 FPS

# appendix

---

## ❖ MPEG4 (CIF)

Quality \ Frame Rate	25 FPS	13 FPS	6 FPS	3 FPS	1 FPS
LEVEL10	1382 Kbps 25 FPS	664 Kbps 12 FPS	332 Kbps 6 FPS	166 Kbps 3 FPS	55 Kbps 1 FPS
LEVEL9	1152 Kbps 25 FPS	553 Kbps 12 FPS	276 Kbps 6 FPS	138 Kbps 3 FPS	46 Kbps 1 FPS
LEVEL8	922 Kbps 25 FPS	442 Kbps 12 FPS	221 Kbps 6 FPS	111 Kbps 3 FPS	37 Kbps 1 FPS
LEVEL7	691 Kbps 25 FPS	332 Kbps 12 FPS	166 Kbps 6 FPS	83 Kbps 3 FPS	28 Kbps 1 FPS
LEVEL6	461 Kbps 25 FPS	221 Kbps 12 FPS	111 Kbps 6 FPS	55 Kbps 3 FPS	18 Kbps 1 FPS
LEVEL5	346 Kbps 25 FPS	166 Kbps 12 FPS	83 Kbps 6 FPS	41 Kbps 3 FPS	14 Kbps 1 FPS
LEVEL4	288 Kbps 25 FPS	138 Kbps 12 FPS	69 Kbps 6 FPS	35 Kbps 3 FPS	12 Kbps 1 FPS
LEVEL3	230 Kbps 25 FPS	111 Kbps 12 FPS	55 Kbps 6 FPS	28 Kbps 3 FPS	9 Kbps 1 FPS
LEVEL2	173 Kbps 25 FPS	83 Kbps 12 FPS	41 Kbps 6 FPS	21 Kbps 3 FPS	7 Kbps 1 FPS
LEVEL1	151 Kbps 25 FPS	73 Kbps 12 FPS	36 Kbps 6 FPS	18 Kbps 3 FPS	6 Kbps 1 FPS

## ❖ H.264 (CIF)

Frame Rate Quality	25 FPS	13 FPS	6 FPS	3 FPS	1 FPS
LEVEL10	922 Kbps 25 FPS	442 Kbps 12 FPS	221 Kbps 6 FPS	111 Kbps 3 FPS	37 Kbps 1 FPS
LEVEL9	691 Kbps 25 FPS	332 Kbps 12 FPS	166 Kbps 6 FPS	83 Kbps 3 FPS	28 Kbps 1 FPS
LEVEL8	576 Kbps 25 FPS	276 Kbps 12 FPS	138 Kbps 6 FPS	69 Kbps 3 FPS	23 Kbps 1 FPS
LEVEL7	461 Kbps 25 FPS	221 Kbps 12 FPS	111 Kbps 6 FPS	55 Kbps 3 FPS	18 Kbps 1 FPS
LEVEL6	346 Kbps 25 FPS	166 Kbps 12 FPS	83 Kbps 6 FPS	41 Kbps 3 FPS	14 Kbps 1 FPS
LEVEL5	288 Kbps 25 FPS	138 Kbps 12 FPS	69 Kbps 6 FPS	35 Kbps 3 FPS	12 Kbps 1 FPS
LEVEL4	230 Kbps 25 FPS	111 Kbps 12 FPS	55 Kbps 6 FPS	28 Kbps 3 FPS	9 Kbps 1 FPS
LEVEL3	173 Kbps 25 FPS	83 Kbps 12 FPS	41 Kbps 6 FPS	21 Kbps 3 FPS	7 Kbps 1 FPS
LEVEL2	115 Kbps 25 FPS	55 Kbps 12 FPS	28 Kbps 6 FPS	14 Kbps 3 FPS	5 Kbps 1 FPS
LEVEL1	58 Kbps 25 FPS	28 Kbps 12 FPS	14 Kbps 6 FPS	7 Kbps 3 FPS	2 Kbps 1 FPS

## TROUBLESHOOTING

PROBLEM	SOLUTION
<p><b>I can't access the camera from a web browser.</b></p>	<ul style="list-style-type: none"> <li>• Check to make sure that the camera's Network settings are appropriate.</li> <li>• Check to make sure that all network cables have been connected properly.</li> <li>• If connected using DHCP, verify that the camera is able to acquire dynamic IP addresses without any problem.</li> <li>• If connected using a DDNS URL, verify that the MAC address has been properly entered.</li> <li>• If the camera is connected to a router, verify that port forwarding is properly configured.</li> </ul>
<p><b>Viewer got disconnected during monitoring.</b></p>	<ul style="list-style-type: none"> <li>• Connected Viewers become disconnected upon any change to camera or network configurations.</li> <li>• Check all network connections.</li> <li>• If the camera is connected over an xDSL network, it's possible for Viewer to disconnect under poor network conditions.</li> </ul>
<p><b>I cannot connect to the system using a tab browser of Internet Explorer 7.0.</b></p>	<ul style="list-style-type: none"> <li>• When you try to connect to the system using a tab browser, the same cookie information is shared, resulting in errors when connected. Therefore, instead of using a tab browser, open a new browser window to connect to the system.</li> </ul>
<p><b>The camera connected to the network is not detected in the IP installer program.</b></p>	<ul style="list-style-type: none"> <li>• Turn off the firewall settings on your PC and then search the camera again.</li> </ul>
<p><b>Images overlap.</b></p>	<ul style="list-style-type: none"> <li>• Check whether two or more cameras are set to a single multicast address instead of different addresses. If a single address is used for multiple cameras, the images may overlap.</li> </ul>
<p><b>No image appears.</b></p>	<ul style="list-style-type: none"> <li>• If the transmission method is set to multicast, check whether there is a router that supports multicast in the LAN the camera is connected to.</li> </ul>

PROBLEM	SOLUTION
<p>No JPEG file is transferred via FTP/SMTP on occurrence of intelligent video analysis event of camera even when the &lt;Intelligent Video Analysis&gt; is set to &lt;Enable&gt;.</p>	<ul style="list-style-type: none"> <li>• Verify the settings in the following sequence:               <ol style="list-style-type: none"> <li>A. NTP must be properly configured.</li> <li>B. The &lt;Intelligent Video Analysis&gt; should be set to &lt;Enable&gt;.</li> <li>C. Alarm Video Transmission must be enabled.</li> <li>D. Check for scheduling conflict.</li> </ol> </li> </ul>
<p>Can &lt;Set Rules&gt; be configured even when the &lt;Intelligent Video Analysis&gt; is set to &lt;Disable&gt;?</p>	<ul style="list-style-type: none"> <li>• Yes, it can be. You can set rules for events despite of the intelligent video analysis setting.</li> </ul>
<p>No signal is found at the Alarm Output port even when an intelligent video analysis event is generated.</p>	<ul style="list-style-type: none"> <li>• Check alarm output port settings.</li> </ul>
<p>Cannot record into the SD memory card.</p>	<ul style="list-style-type: none"> <li>• Check if the memory card is defective.</li> <li>• Check if the write protection tab of the memory card is set to "LOCK".</li> </ul>
<p>SD memory indicator does not turn on even when the SD memory card is inserted.</p>	<ul style="list-style-type: none"> <li>• Check if the memory card is defective.</li> <li>• Check if the &lt;SD Card Record&gt; is checked in &lt;Setup&gt; - &lt;Event&gt; - &lt;Alarm image&gt; menu.</li> </ul>
<p>SD memory card is inserted but the camera does not operate properly.</p>	<ul style="list-style-type: none"> <li>• Check if the memory card is inserted in the proper direction. Operation of memory card that is formatted by other devices is not guaranteed with this camera unit</li> <li>• Format the memory card again in &lt;Setup&gt; - &lt;Event&gt; - &lt;Record setup&gt; menu.</li> </ul>
<p>Cannot format the SD memory card.</p>	<ul style="list-style-type: none"> <li>• Check if the write protection tab of the memory card is set to "LOCK".</li> </ul>

# GPL/LGPL SOFTWARE LICENSE

---

This product uses open-source software distributed under the terms of GPL and LGPL.

And you can visit at [www.samsungsecurity.com](http://www.samsungsecurity.com) to get the source codes of the following GPL and LGPL software used for this product.

- GPL S/W
    - Base Kernel, Busybox, Sysvinit, dosfstools
  - LGPL S/W
    - gLibc, Inetutils
- 

## GNU GENERAL PUBLIC LICENSE

Version 2, June 1991

Copyright (C)1989, 1991 Free Software Foundation, Inc.

51 Franklin Street, Fifth Floor, Boston, MA 02110-1301, USA

Everyone is permitted to copy and distribute verbatim copies of this license document, but changing it is not allowed.

### Preamble

The licenses for most software are designed to take away your freedom to share and change it. By contrast, the GNU General Public License is intended to guarantee your freedom to share and change free software-- to make sure the software is free for all its users.

This General Public License applies to most of the Free Software Foundation's software and to any other program whose authors commit to using it. (Some other Free Software Foundation software is covered by the GNU Lesser General Public License instead.) You can apply it to your programs, too.

When we speak of free software, we are referring to freedom, not price.

Our General Public Licenses are designed to make sure that you have the freedom to distribute copies of free software (and charge for this service if you wish), that you receive source code or can get it if you

want it, that you can change the software or use pieces of it in new free programs ; and that you know you can do these things.

To protect your rights, we need to make restrictions that forbid anyone to deny you these rights or to ask you to surrender the rights. These restrictions translate to certain responsibilities for you if you distribute copies of the software, or if you modify it.

For example, if you distribute copies of such a program, whether gratis or for a fee, you must give the recipients all the rights that you have.

You must make sure that they, too, receive or can get the source code. And you must show them these terms so they know their rights.

We protect your rights with two steps :

(1)copyright the software, and (2)offer you this license which gives you legal permission to copy, distribute and/or modify the software.

Also, for each author's protection and ours, we want to make certain that everyone understands that there is no warranty for this free software. If the software is modified by someone else and passed on, we want its recipients to know that what they have is not the original, so that any problems introduced by others will not reflect on the original authors' reputations.

Finally, any free program is threatened constantly by software patents. We wish

to avoid the danger that redistributors of a free program will individually obtain patent licenses, in effect making the program proprietary. To prevent this, we have made it clear that any patent must be licensed for everyone's free use or not licensed at all.

The precise terms and conditions for copying, distribution and modification follow.

## **TERMS AND CONDITIONS FOR COPYING, DISTRIBUTION AND MODIFICATION**

0. This License applies to any program or other work which contains a notice placed by the copyright holder saying it may be distributed under the terms of this General Public License. The "Program", below, refers to any such program or work, and a "work based on the Program" means either the Program or any derivative work under copyright law : that is to say, a work containing the Program or a portion of it, either verbatim or with modifications and/or translated into another language. (Hereinafter, translation is included without limitation in the term "modification".) Each licensee is addressed as "you". Activities other than copying, distribution and modification are not covered by this License ; they are outside its scope. The act of running the Program is not restricted, and the output from the Program is covered only if its contents constitute a work based on the Program (independent of having been made by running the Program). Whether that is true depends on what the Program does.

1. You may copy and distribute verbatim copies of the Program's source code as you receive it, in any medium, provided that you conspicuously and appropriately publish on each copy an appropriate copyright notice and disclaimer of warranty; keep intact all the notices that refer to this License and to the absence of any warranty ; and give any other

recipients of the Program a copy of this License along with the Program.

You may charge a fee for the physical act of transferring a copy, and you may at your option offer warranty protection in exchange for a fee.

2. You may modify your copy or copies of the Program or any portion of it, thus forming a work based on the Program, and copy and distribute such modifications or work under the terms of Section 1 above, provided that you also meet all of these conditions :

- a) You must cause the modified files to carry prominent notices stating that you changed the files and the date of any change.
- b) You must cause any work that you distribute or publish, that in whole or in part contains or is derived from the Program or any part thereof, to be licensed as a whole at no charge to all third parties under the terms of this License.
- c) If the modified program normally reads commands interactively when run, you must cause it, when started running for such interactive use in the most ordinary way, to print or display an announcement including an appropriate copyright notice and a notice that there is no warranty (or else, saying that you provide a warranty) and that users may redistribute the program under these conditions, and telling the user how to view a copy of this License. (Exception: if the Program itself is interactive but does not normally print such an announcement, your work based on the Program is not required to print an announcement.)

These requirements apply to the modified work as a whole. If identifiable sections of that work are not derived from the Program, and can be reasonably

considered independent and separate works in themselves, then this License, and its terms, do not apply to those sections when you distribute them as separate works. But when you distribute the same sections as part of a whole which is a work based on the Program, the distribution of the whole must be on the terms of this License, whose permissions for other licensees extend to the entire whole, and thus to each and every part regardless of who wrote it.

Thus, it is not the intent of this section to claim rights or contest your rights to work written entirely by you ; rather, the intent is to exercise the right to control the distribution of derivative or collective works based on the Program. In addition, mere aggregation of another work not based on the Program with the Program (or with a work based on the Program) on a volume of a storage or distribution medium does not bring the other work under the scope of this License.

3. You may copy and distribute the Program (or a work based on it, under Section 2) in object code or executable form under the terms of Sections 1 and 2 above provided that you also do one of the following :

- a) Accompany it with the complete corresponding machine-readable source code, which must be distributed under the terms of Sections 1 and 2 above on a medium customarily used for software interchange ; or,
- b) Accompany it with a written offer, valid for at least three years, to give any third party, for a charge no more than your cost of physically performing source distribution, a complete machine-readable copy of the corresponding source code, to be distributed under the terms of Sections 1 and 2 above on a medium customarily used for software interchange ; or,

- c) Accompany it with the information you received as to the offer to distribute corresponding source code. (This alternative is allowed only for noncommercial distribution and only if you received the program in object code or executable form with such an offer, in accord with Subsection b above.)

The source code for a work means the preferred form of the work for making modifications to it. For an executable work, complete source code means all the source code for all modules it contains, plus any associated interface definition files, plus the scripts used to control compilation and installation of the executable. However, as a special exception, the source code distributed need not include anything that is normally distributed (in either source or binary form) with the major components (compiler, kernel, and so on) of the operating system on which the executable runs, unless that component itself accompanies the executable.

If distribution of executable or object code is made by offering access to copy from a designated place, then offering equivalent access to copy the source code from the same place counts as distribution of the source code, even though third parties are not compelled to copy the source along with the object code.

- 4. You may not copy, modify, sublicense, or distribute the Program except as expressly provided under this License. Any attempt otherwise to copy, modify, sublicense or distribute the Program is void, and will automatically terminate your rights under this License. However, parties who have received copies, or rights, from you under this License will not have their licenses terminated so long as such parties remain in full compliance.
- 5. You are not required to accept this License, since you have not signed it.



However, nothing else grants you permission to modify or distribute the Program or its derivative works.

These actions are prohibited by law if you do not accept this License. Therefore, by modifying or distributing the Program (or any work based on the Program), you indicate your acceptance of this License to do so, and all its terms and conditions for copying, distributing or modifying the Program or works based on it.

6. Each time you redistribute the Program (or any work based on the Program), the recipient automatically receives a license from the original licensor to copy, distribute or modify the Program subject to these terms and conditions. You may not impose any further restrictions on the recipients' exercise of the rights granted herein. You are not responsible for enforcing compliance by third parties to this License.
7. If, as a consequence of a court judgment or allegation of patent infringement or for any other reason (not limited to patent issues), conditions are imposed on you (whether by court order, agreement or otherwise) that contradict the conditions of this License, they do not excuse you from the conditions of this License. If you cannot distribute so as to satisfy simultaneously your obligations under this License and any other pertinent obligations, then as a consequence you may not distribute the Program at all. For example, if a patent license would not permit royalty-free redistribution of the Program by all those who receive copies directly or indirectly through you, then the only way you could satisfy both it and this License would be to refrain entirely from distribution of the Program.

If any portion of this section is held invalid or unenforceable under any particular circumstance, the balance of the section is intended to apply and the section as

a whole is intended to apply in other circumstances. It is not the purpose of this section to induce you to infringe any patents or other property right claims or to contest validity of any such claims; this section has the sole purpose of protecting the integrity of the free software distribution system, which is implemented by public license practices. Many people have made generous contributions to the wide range of software distributed through that system in reliance on consistent application of that system; it is up to the author/donor to decide if he or she is willing to distribute software through any other system and a licensee cannot impose that choice.

This section is intended to make thoroughly clear what is believed to be a consequence of the rest of this License.

8. If the distribution and/or use of the Program is restricted in certain countries either by patents or by copyrighted interfaces, the original copyright holder who places the Program under this License may add an explicit geographical distribution limitation excluding those countries, so that distribution is permitted only in or among countries not thus excluded. In such case, this License incorporates the limitation as if written in the body of this License.
9. The Free Software Foundation may publish revised and/or new versions of the General Public License from time to time. Such new versions will be similar in spirit to the present version, but may differ in detail to address new problems or concerns.

Each version is given a distinguishing version number. If the Program specifies a version number of this License which applies to it and "any later version", you have the option of following the terms and conditions either of that version or of any later version published by the Free Software Foundation. If the Program does not specify a version number of this License, you may

choose any version ever published by the Free Software Foundation.

10. If you wish to incorporate parts of the Program into other free programs whose distribution conditions are different, write to the author to ask for permission. For software which is copyrighted by the Free Software Foundation, write to the Free Software Foundation; we sometimes make exceptions for this. Our decision will be guided by the two goals of preserving the free status of all derivatives of our free software and of promoting the sharing and reuse of software generally.

## **NO WARRANTY**

11. BECAUSE THE PROGRAM IS LICENSED FREE OF CHARGE, THERE IS NO WARRANTY FOR THE PROGRAM, TO THE EXTENT PERMITTED BY APPLICABLE LAW. EXCEPT WHEN OTHERWISE STATED IN WRITING THE COPYRIGHT HOLDERS AND/OR OTHER PARTIES PROVIDE THE PROGRAM "ASIS" WITHOUT WARRANTY OF ANY KIND, EITHER EXPRESSED OR IMPLIED, INCLUDING, BUT NOT LIMITED TO, THE IMPLIED WARRANTIES OF MERCHANTABILITY AND FITNESS FOR A PARTICULAR PURPOSE. THE ENTIRE RISK AS TO THE QUALITY AND PERFORMANCE OF THE PROGRAM IS WITH YOU. SHOULD THE PROGRAM PROVE DEFECTIVE, YOU ASSUME THE COST OF ALL NECESSARY SERVICING, REPAIR OR CORRECTION.
12. IN NO EVENT UNLESS REQUIRED BY APPLICABLE LAW OR AGREED TO IN WRITING WILL ANY COPYRIGHT HOLDER, OR ANY OTHER PARTY WHO MAY MODIFY AND/OR REDISTRIBUTE DAMAGES, INCLUDING ANY GENERAL, SPECIAL, INCIDENTAL OR CONSEQUENTIAL DAMAGES ARISING OUT OF THE

USE OR INABILITY TO USE THE PROGRAM (INCLUDING BUT NOT LIMITED TO LOSS OF DATA OR DATA BEING RENDERED INACCURATE OR LOSSES SUSTAINED BY YOU OR THIRD PARTIES OR A FAILURE OF THE PROGRAM TO OPERATE WITH ANY OTHER PROGRAMS), EVEN IF SUCH HOLDER OR OTHER PARTY HAS BEEN ADVISED OF THE POSSIBILITY OF SUCH DAMAGES.

## **END OF TERMS AND CONDITIONS**

### **How to Apply These Terms to Your New Programs**

If you develop a new program, and you want it to be of the greatest possible use to the public, the best way to achieve this is to make it free software which everyone can redistribute and change under these terms.

To do so, attach the following notices to the program. It is safest to attach them to the start of each source file to most effectively convey the exclusion of warranty; and each file should have at least the "copyright" line and a pointer to where the full notice is found.

one line to give the program's name and an idea of what it does.

Copyright (C)yyyy name of author

This program is free software; you can redistribute it and/or modify it under the terms of the GNU General Public License as published by the Free Software Foundation; either version 2 of the License, or (at your option) any later version.

This program is distributed in the hope that it will be useful, but WITHOUT ANY WARRANTY; without even the implied warranty of MERCHANTABILITY or FITNESS FOR A PARTICULAR PURPOSE. See the GNU General Public License for more details.

You should have received a copy of the GNU General Public License along with this program ; if not, write to the Free Software Foundation, Inc.,51 Franklin Street, Fifth Floor, Boston, MA 02110-1301, USA.

Also add information on how to contact you by electronic and paper mail. If the program is interactive, make it output a short notice like this when it starts in an interactive mode :

Gnomovision version 69,

Copyright (C) year name of author

Gnomovision comes with ABSOLUTELY NO

WARRANTY ; for details type 'show w'.

This is free software, and you are welcome to redistribute it under certain conditions ; type 'show c' for details.

The hypothetical commands 'show w' and 'show c' should show the appropriate parts of the General Public License. Of course, the commands you use may be called something other than 'show w' and 'show c' ; they could even be mouse-clicks or menu items-- whatever suits your program.

You should also get your employer (if you work as a programmer) or your school, if any, to sign a "copyright disclaimer" for the program, if necessary. Here is a sample ; alter the names:

Yoyodyne, Inc., hereby disclaims all copyright interest in the program 'Gnomovision' (which makes passes at compilers) written by James Hacker.

signature of Ty Coon, 1 April 1989 Ty Coon, President of Vice This General Public License does not permit incorporating your program into proprietary programs. If your program is a subroutine library, you may consider it more useful to permit linking proprietary applications with the library. If this is what you want to do, use the **GNU Lesser General Public License** instead of this License.

## GNU GENERAL PUBLIC LICENSE

Version 3, 29 June 2007

Copyright © 2007 Free Software Foundation, Inc. <<http://fsf.org/>>

Everyone is permitted to copy and distribute verbatim copies of this license document, but changing it is not allowed.

## Preamble

The GNU General Public License is a free, copyleft license for software and other kinds of works.

The licenses for most software and other practical works are designed to take away your freedom to share and change the works. By contrast, the GNU General Public License is intended to guarantee your freedom to share and change all versions of a program-- to make sure it remains free software for all its users. We, the Free Software Foundation, use the GNU General Public License for most of our software; it applies also to any other work released this way by its authors. You can apply it to your programs, too.

When we speak of free software, we are referring to freedom, not price. Our General Public Licenses are designed to make sure that you have the freedom to distribute copies of free software (and charge for them if you wish), that you receive source code or can get it if you want it, that you can change the software or use pieces of it in new free programs, and that you know you can do these things.

To protect your rights, we need to prevent others from denying you these rights or asking you to surrender the rights. Therefore, you have certain responsibilities if you distribute copies of the software, or if you modify it: responsibilities to respect the freedom of others.

For example, if you distribute copies of such a program, whether gratis or for a fee, you must pass on to the recipients the same freedoms

that you received. You must make sure that they, too, receive or can get the source code. And you must show them these terms so they know their rights.

Developers that use the GNU GPL protect your rights with two steps: (1) assert copyright on the software, and (2) offer you this License giving you legal permission to copy, distribute and/or modify it.

For the developers' and authors' protection, the GPL clearly explains that there is no warranty for this free software. For both users' and authors' sake, the GPL requires that modified versions be marked as changed, so that their problems will not be attributed erroneously to authors of previous versions.

Some devices are designed to deny users access to install or run modified versions of the software inside them, although the manufacturer can do so. This is fundamentally incompatible with the aim of protecting users' freedom to change the software. The systematic pattern of such abuse occurs in the area of products for individuals to use, which is precisely where it is most unacceptable. Therefore, we have designed this version of the GPL to prohibit the practice for those products. If such problems arise substantially in other domains, we stand ready to extend this provision to those domains in future versions of the GPL, as needed to protect the freedom of users.

Finally, every program is threatened constantly by software patents. States should not allow patents to restrict development and use of software on general-purpose computers, but in those that do, we wish to avoid the special danger that patents applied to a free program could make it effectively proprietary. To prevent this, the GPL assures that patents cannot be used to render the program non-free.

The precise terms and conditions for copying, distribution and modification follow.

## TERMS AND CONDITIONS

### 0. Definitions.

"This License" refers to version 3 of the GNU General Public License.

"Copyright" also means copyright-like laws that apply to other kinds of works, such as semiconductor masks.

"The Program" refers to any copyrightable work licensed under this License. Each licensee is addressed as "you". "Licensees" and "recipients" may be individuals or organizations.

To "modify" a work means to copy from or adapt all or part of the work in a fashion requiring copyright permission, other than the making of an exact copy. The resulting work is called a "modified version" of the earlier work or a work "based on" the earlier work.

A "covered work" means either the unmodified Program or a work based on the Program.

To "propagate" a work means to do anything with it that, without permission, would make you directly or secondarily liable for infringement under applicable copyright law, except executing it on a computer or modifying a private copy. Propagation includes copying, distribution (with or without modification), making available to the public, and in some countries other activities as well.

To "convey" a work means any kind of propagation that enables other parties to make or receive copies. Mere interaction with a user through a computer network, with no transfer of a copy, is not conveying.

An interactive user interface displays "Appropriate Legal Notices" to the extent that it includes a convenient and prominently visible feature that (1) displays an appropriate copyright notice, and (2) tells the user that there is no warranty for the work (except to the extent that warranties are provided), that licensees may convey the work under this License, and how to view a copy of this License.

If the interface presents a list of user commands or options, such as a menu, a prominent item in the list meets this criterion.

## 1. Source Code.

The “source code” for a work means the preferred form of the work for making modifications to it. “Object code” means any non-source form of a work.

A “Standard Interface” means an interface that either is an official standard defined by a recognized standards body, or, in the case of interfaces specified for a particular programming language, one that is widely used among developers working in that language.

The “System Libraries” of an executable work include anything, other than the work as a whole, that (a) is included in the normal form of packaging a Major Component, but which is not part of that Major Component, and (b) serves only to enable use of the work with that Major Component, or to implement a Standard Interface for which an implementation is available to the public in source code form. A “Major Component”, in this context, means a major essential component (kernel, window system, and so on) of the specific operating system (if any) on which the executable work runs, or a compiler used to produce the work, or an object code interpreter used to run it.

The “Corresponding Source” for a work in object code form means all the source code needed to generate, install, and (for an executable work) run the object code and to modify the work, including scripts to control those activities. However, it does not include the work’s System Libraries, or general-purpose tools or generally available free programs which are used unmodified in performing those activities but which are not part of the work. For example, Corresponding Source includes interface definition files associated with source files for the work, and the source code for shared libraries and dynamically linked subprograms that the work is specifically designed to require, such as by intimate data communication or control flow between those subprograms and other parts of the work.

The Corresponding Source need not include anything that users can regenerate automatically from other parts of the Corresponding Source.

The Corresponding Source for a work in source code form is that same work.

## 2. Basic Permissions.

All rights granted under this License are granted for the term of copyright on the Program, and are irrevocable provided the stated conditions are met. This License explicitly affirms your unlimited permission to run the unmodified Program. The output from running a covered work is covered by this License only if the output, given its content, constitutes a covered work. This License acknowledges your rights of fair use or other equivalent, as provided by copyright law.

You may make, run and propagate covered works that you do not convey, without conditions so long as your license otherwise remains in force. You may convey covered works to others for the sole purpose of having them make modifications exclusively for you, or provide you with facilities for running those works, provided that you comply with the terms of this License in conveying all material for which you do not control copyright. Those thus making or running the covered works for you must do so exclusively on your behalf, under your direction and control, on terms that prohibit them from making any copies of your copyrighted material outside their relationship with you.

Conveying under any other circumstances is permitted solely under the conditions stated below. Sublicensing is not allowed; section 10 makes it unnecessary.

## 3. Protecting Users' Legal Rights From Anti-Circumvention Law.

No covered work shall be deemed part of an effective technological measure under any applicable law fulfilling obligations under article 11 of the WIPO copyright treaty adopted on 20 December 1996, or similar laws prohibiting or restricting circumvention of such measures.

When you convey a covered work, you waive any legal power to forbid circumvention of technological measures to the extent such circumvention is effected by exercising rights under this License with respect to the covered work, and you disclaim any intention to limit operation or modification of the work as a means of enforcing, against the work's users, your or third parties' legal rights to forbid circumvention of technological measures.

#### **4. Conveying Verbatim Copies.**

You may convey verbatim copies of the Program's source code as you receive it, in any medium, provided that you conspicuously and appropriately publish on each copy an appropriate copyright notice; keep intact all notices stating that this License and any non-permissive terms added in accord with section 7 apply to the code; keep intact all notices of the absence of any warranty; and give all recipients a copy of this License along with the Program.

You may charge any price or no price for each copy that you convey, and you may offer support or warranty protection for a fee.

#### **5. Conveying Modified Source Versions.**

You may convey a work based on the Program, or the modifications to produce it from the Program, in the form of source code under the terms of section 4, provided that you also meet all of these conditions:

- a) The work must carry prominent notices stating that you modified it, and giving a relevant date.
- b) The work must carry prominent notices stating that it is released under this License and any conditions added under section 7. This requirement modifies the requirement in section 4 to "keep intact all notices".
- c) You must license the entire work, as a whole, under this License to anyone who comes into possession of a copy. This License will therefore apply, along with any applicable section 7 additional terms, to the whole of the work, and all its parts, regardless of how they are packaged.

This License gives no permission to license the work in any other way, but it does not invalidate such permission if you have separately received it.

- d) If the work has interactive user interfaces, each must display Appropriate Legal Notices; however, if the Program has interactive interfaces that do not display Appropriate Legal Notices, your work need not make them do so.

A compilation of a covered work with other separate and independent works, which are not by their nature extensions of the covered work, and which are not combined with it such as to form a larger program, in or on a volume of a storage or distribution medium, is called an "aggregate" if the compilation and its resulting copyright are not used to limit the access or legal rights of the compilation's users beyond what the individual works permit. Inclusion of a covered work in an aggregate does not cause this License to apply to the other parts of the aggregate.

#### **6. Conveying Non-Source Forms.**

You may convey a covered work in object code form under the terms of sections 4 and 5, provided that you also convey the machine-readable Corresponding Source under the terms of this License, in one of these ways:

- a) Convey the object code in, or embodied in, a physical product (including a physical distribution medium), accompanied by the Corresponding Source fixed on a durable physical medium customarily used for software interchange.
- b) Convey the object code in, or embodied in, a physical product (including a physical distribution medium), accompanied by a written offer, valid for at least three years and valid for as long as you offer spare parts or customer support for that product model, to give anyone who possesses the object code either (1) a copy of the Corresponding Source for all the software in the product that is covered by this License, on a durable physical medium customarily used for software interchange, for a price no more than your

reasonable cost of physically performing this conveying of source, or (2) access to copy the Corresponding Source from a network server at no charge.

- c) Convey individual copies of the object code with a copy of the written offer to provide the Corresponding Source. This alternative is allowed only occasionally and noncommercially, and only if you received the object code with such an offer, in accord with subsection 6b.
- d) Convey the object code by offering access from a designated place (gratis or for a charge), and offer equivalent access to the Corresponding Source in the same way through the same place at no further charge. You need not require recipients to copy the Corresponding Source along with the object code. If the place to copy the object code is a network server, the Corresponding Source may be on a different server (operated by you or a third party) that supports equivalent copying facilities, provided you maintain clear directions next to the object code saying where to find the Corresponding Source. Regardless of what server hosts the Corresponding Source, you remain obligated to ensure that it is available for as long as needed to satisfy these requirements.
- e) Convey the object code using peer-to-peer transmission, provided you inform other peers where the object code and Corresponding Source of the work are being offered to the general public at no charge under subsection 6d.

A separable portion of the object code, whose source code is excluded from the Corresponding Source as a System Library, need not be included in conveying the object code work.

A "User Product" is either (1) a "consumer product", which means any tangible personal property which is normally used for personal, family, or household purposes, or (2) anything designed or sold for incorporation into a dwelling. In determining whether a product is a consumer product, doubtful cases shall be

resolved in favor of coverage. For a particular product received by a particular user, "normally used" refers to a typical or common use of that class of product, regardless of the status of the particular user or of the way in which the particular user actually uses, or expects or is expected to use, the product. A product is a consumer product regardless of whether the product has substantial commercial, industrial or non-consumer uses, unless such uses represent the only significant mode of use of the product.

"Installation Information" for a User Product means any methods, procedures, authorization keys, or other information required to install and execute modified versions of a covered work in that User Product from a modified version of its Corresponding Source. The information must suffice to ensure that the continued functioning of the modified object code is in no case prevented or interfered with solely because modification has been made.

If you convey an object code work under this section in, or with, or specifically for use in, a User Product, and the conveying occurs as part of a transaction in which the right of possession and use of the User Product is transferred to the recipient in perpetuity or for a fixed term (regardless of how the transaction is characterized), the Corresponding Source conveyed under this section must be accompanied by the Installation Information. But this requirement does not apply if neither you nor any third party retains the ability to install modified object code on the User Product (for example, the work has been installed in ROM).

The requirement to provide Installation Information does not include a requirement to continue to provide support service, warranty, or updates for a work that has been modified or installed by the recipient, or for the User Product in which it has been modified or installed. Access to a network may be denied when the modification itself materially and adversely affects the operation of the network or violates the rules and protocols for communication across the network.

Corresponding Source conveyed, and Installation Information provided, in accord with this section must be in a format that is publicly documented (and with an implementation available to the public in source code form), and must require no special password or key for unpacking, reading or copying.

## 7. Additional Terms.

“Additional permissions” are terms that supplement the terms of this License by making exceptions from one or more of its conditions. Additional permissions that are applicable to the entire Program shall be treated as though they were included in this License, to the extent that they are valid under applicable law. If additional permissions apply only to part of the Program, that part may be used separately under those permissions, but the entire Program remains governed by this License without regard to the additional permissions.

When you convey a copy of a covered work, you may at your option remove any additional permissions from that copy, or from any part of it. (Additional permissions may be written to require their own removal in certain cases when you modify the work.) You may place additional permissions on material, added by you to a covered work, for which you have or can give appropriate copyright permission.

Notwithstanding any other provision of this License, for material you add to a covered work, you may (if authorized by the copyright holders of that material) supplement the terms of this License with terms:

- a) Disclaiming warranty or limiting liability differently from the terms of sections 15 and 16 of this License; or
- b) Requiring preservation of specified reasonable legal notices or author attributions in that material or in the Appropriate Legal Notices displayed by works containing it; or
- c) Prohibiting misrepresentation of the origin of that material, or requiring that modified versions of such material be marked in

reasonable ways as different from the original version; or

- d) Limiting the use for publicity purposes of names of licensors or authors of the material; or
- e) Declining to grant rights under trademark law for use of some trade names, trademarks, or service marks; or
- f) Requiring indemnification of licensors and authors of that material by anyone who conveys the material (or modified versions of it) with contractual assumptions of liability to the recipient, for any liability that these contractual assumptions directly impose on those licensors and authors.

All other non-permissive additional terms are considered “further restrictions” within the meaning of section 10. If the Program as you received it, or any part of it, contains a notice stating that it is governed by this License along with a term that is a further restriction, you may remove that term. If a license document contains a further restriction but permits relicensing or conveying under this License, you may add to a covered work material governed by the terms of that license document, provided that the further restriction does not survive such relicensing or conveying.

If you add terms to a covered work in accord with this section, you must place, in the relevant source files, a statement of the additional terms that apply to those files, or a notice indicating where to find the applicable terms.

Additional terms, permissive or non-permissive, may be stated in the form of a separately written license, or stated as exceptions; the above requirements apply either way.

## 8. Termination.

You may not propagate or modify a covered work except as expressly provided under this License. Any attempt otherwise to propagate or modify it is void, and will automatically terminate your rights under this License (including any patent licenses granted under the third paragraph of section 11).



However, if you cease all violation of this License, then your license from a particular copyright holder is reinstated (a) provisionally, unless and until the copyright holder explicitly and finally terminates your license, and (b) permanently, if the copyright holder fails to notify you of the violation by some reasonable means prior to 60 days after the cessation.

Moreover, your license from a particular copyright holder is reinstated permanently if the copyright holder notifies you of the violation by some reasonable means, this is the first time you have received notice of violation of this License (for any work) from that copyright holder, and you cure the violation prior to 30 days after your receipt of the notice.

Termination of your rights under this section does not terminate the licenses of parties who have received copies or rights from you under this License. If your rights have been terminated and not permanently reinstated, you do not qualify to receive new licenses for the same material under section 10.

## **9. Acceptance Not Required for Having Copies.**

You are not required to accept this License in order to receive or run a copy of the Program. Ancillary propagation of a covered work occurring solely as a consequence of using peer-to-peer transmission to receive a copy likewise does not require acceptance. However, nothing other than this License grants you permission to propagate or modify any covered work. These actions infringe copyright if you do not accept this License. Therefore, by modifying or propagating a covered work, you indicate your acceptance of this License to do so.

## **10. Automatic Licensing of Downstream Recipients.**

Each time you convey a covered work, the recipient automatically receives a license from the original licensors, to run, modify and propagate that work, subject to this License. You are not responsible for enforcing compliance by third parties with this License.

An “entity transaction” is a transaction transferring control of an organization, or substantially all assets of one, or subdividing an organization, or merging organizations. If propagation of a covered work results from an entity transaction, each party to that transaction who receives a copy of the work also receives whatever licenses to the work the party’s predecessor in interest had or could give under the previous paragraph, plus a right to possession of the Corresponding Source of the work from the predecessor in interest, if the predecessor has it or can get it with reasonable efforts.

You may not impose any further restrictions on the exercise of the rights granted or affirmed under this License. For example, you may not impose a license fee, royalty, or other charge for exercise of rights granted under this License, and you may not initiate litigation (including a cross-claim or counterclaim in a lawsuit) alleging that any patent claim is infringed by making, using, selling, offering for sale, or importing the Program or any portion of it.

## **11. Patents.**

A “contributor” is a copyright holder who authorizes use under this License of the Program or a work on which the Program is based. The work thus licensed is called the contributor’s “contributor version”.

A contributor’s “essential patent claims” are all patent claims owned or controlled by the contributor, whether already acquired or hereafter acquired, that would be infringed by some manner, permitted by this License, of making, using, or selling its contributor version, but do not include claims that would be infringed only as a consequence of further modification of the contributor version. For purposes of this definition, “control” includes the right to grant patent sublicenses in a manner consistent with the requirements of this License.

Each contributor grants you a non-exclusive, worldwide, royalty-free patent license under the contributor’s essential patent claims, to make, use, sell, offer for sale, import and otherwise run, modify and propagate the contents of its contributor version.

In the following three paragraphs, a “patent license” is any express agreement or commitment, however denominated, not to enforce a patent (such as an express permission to practice a patent or covenant not to sue for patent infringement). To “grant” such a patent license to a party means to make such an agreement or commitment not to enforce a patent against the party.

If you convey a covered work, knowingly relying on a patent license, and the Corresponding Source of the work is not available for anyone to copy, free of charge and under the terms of this License, through a publicly available network server or other readily accessible means, then you must either (1) cause the Corresponding Source to be so available, or (2) arrange to deprive yourself of the benefit of the patent license for this particular work, or (3) arrange, in a manner consistent with the requirements of this License, to extend the patent license to downstream recipients. “Knowingly relying” means you have actual knowledge that, but for the patent license, your conveying the covered work in a country, or your recipient’s use of the covered work in a country, would infringe one or more identifiable patents in that country that you have reason to believe are valid.

If, pursuant to or in connection with a single transaction or arrangement, you convey, or propagate by procuring conveyance of, a covered work, and grant a patent license to some of the parties receiving the covered work authorizing them to use, propagate, modify or convey a specific copy of the covered work, then the patent license you grant is automatically extended to all recipients of the covered work and works based on it.

A patent license is “discriminatory” if it does not include within the scope of its coverage, prohibits the exercise of, or is conditioned on the non-exercise of one or more of the rights that are specifically granted under this License. You may not convey a covered work if you are a party to an arrangement with a third party that is in the business of distributing

software, under which you make payment to the third party based on the extent of your activity of conveying the work, and under which the third party grants, to any of the parties who would receive the covered work from you, a discriminatory patent license (a) in connection with copies of the covered work conveyed by you (or copies made from those copies), or (b) primarily for and in connection with specific products or compilations that contain the covered work, unless you entered into that arrangement, or that patent license was granted, prior to 28 March 2007.

Nothing in this License shall be construed as excluding or limiting any implied license or other defenses to infringement that may otherwise be available to you under applicable patent law.

## **12. No Surrender of Others' Freedom.**

If conditions are imposed on you (whether by court order, agreement or otherwise) that contradict the conditions of this License, they do not excuse you from the conditions of this License. If you cannot convey a covered work so as to satisfy simultaneously your obligations under this License and any other pertinent obligations, then as a consequence you may not convey it at all. For example, if you agree to terms that obligate you to collect a royalty for further conveying from those to whom you convey the Program, the only way you could satisfy both those terms and this License would be to refrain entirely from conveying the Program.

## **13. Use with the GNU Affero General Public License.**

Notwithstanding any other provision of this License, you have permission to link or combine any covered work with a work licensed under version 3 of the GNU Affero General Public License into a single combined work, and to convey the resulting work. The terms of this License will continue to apply to the part which is the covered work, but the special requirements of the GNU Affero General Public License, section 13, concerning interaction through a network will apply to the combination as such.

#### **14. Revised Versions of this License.**

The Free Software Foundation may publish revised and/or new versions of the GNU General Public License from time to time. Such new versions will be similar in spirit to the present version, but may differ in detail to address new problems or concerns.

Each version is given a distinguishing version number. If the Program specifies that a certain numbered version of the GNU General Public License "or any later version" applies to it, you have the option of following the terms and conditions either of that numbered version or of any later version published by the Free Software Foundation. If the Program does not specify a version number of the GNU General Public License, you may choose any version ever published by the Free Software Foundation.

If the Program specifies that a proxy can decide which future versions of the GNU General Public License can be used, that proxy's public statement of acceptance of a version permanently authorizes you to choose that version for the Program.

Later license versions may give you additional or different permissions. However, no additional obligations are imposed on any author or copyright holder as a result of your choosing to follow a later version.

#### **15. Disclaimer of Warranty.**

THERE IS NO WARRANTY FOR THE PROGRAM, TO THE EXTENT PERMITTED BY APPLICABLE LAW. EXCEPT WHEN OTHERWISE STATED IN WRITING THE COPYRIGHT HOLDERS AND/OR OTHER PARTIES PROVIDE THE PROGRAM "AS IS" WITHOUT WARRANTY OF ANY KIND, EITHER EXPRESSED OR IMPLIED, INCLUDING, BUT NOT LIMITED TO, THE IMPLIED WARRANTIES OF MERCHANTABILITY AND FITNESS FOR A PARTICULAR PURPOSE. THE ENTIRE RISK AS TO THE QUALITY AND PERFORMANCE OF THE PROGRAM IS WITH YOU. SHOULD THE PROGRAM PROVE DEFECTIVE, YOU ASSUME THE COST OF ALL NECESSARY SERVICING, REPAIR OR CORRECTION.

#### **16. Limitation of Liability.**

IN NO EVENT UNLESS REQUIRED BY APPLICABLE LAW OR AGREED TO IN WRITING WILL ANY COPYRIGHT HOLDER, OR ANY OTHER PARTY WHO MODIFIES AND/OR CONVEYS THE PROGRAM AS PERMITTED ABOVE, BE LIABLE TO YOU FOR DAMAGES, INCLUDING ANY GENERAL, SPECIAL, INCIDENTAL OR CONSEQUENTIAL DAMAGES ARISING OUT OF THE USE OR INABILITY TO USE THE PROGRAM (INCLUDING BUT NOT LIMITED TO LOSS OF DATA OR DATA BEING RENDERED INACCURATE OR LOSSES SUSTAINED BY YOU OR THIRD PARTIES OR A FAILURE OF THE PROGRAM TO OPERATE WITH ANY OTHER PROGRAMS), EVEN IF SUCH HOLDER OR OTHER PARTY HAS BEEN ADVISED OF THE POSSIBILITY OF SUCH DAMAGES.

#### **17. Interpretation of Sections 15 and 16.**

If the disclaimer of warranty and limitation of liability provided above cannot be given local legal effect according to their terms, reviewing courts shall apply local law that most closely approximates an absolute waiver of all civil liability in connection with the Program, unless a warranty or assumption of liability accompanies a copy of the Program in return for a fee.

END OF TERMS AND CONDITIONS

### **GNU LESSER GENERAL PUBLIC LICENSE**

Version 2.1, February 1999

Copyright (C)1991, 1999 Free Software Foundation, Inc.

51 Franklin Street, Fifth Floor, Boston, MA 02110-1301 USA

Everyone is permitted to copy and distribute verbatim copies of this license document, but changing it is not allowed.

[This is the first released version of the Lesser GPL. It also counts as the successor of the GNU Library Public License, version 2, hence the version number 2.1.]

## Preamble

The licenses for most software are designed to take away your freedom to share and change it. By contrast, the GNU General Public Licenses are intended to guarantee your freedom to share and change free software--to make sure the software is free for all its users.

This license, the Lesser General Public License, applies to some specially designated software packages--typically libraries--of the Free Software Foundation and other authors who decide to use it. You can use it too, but we suggest you first think carefully about whether this license or the ordinary General Public License is the better strategy to use in any particular case, based on the explanations below.

When we speak of free software, we are referring to freedom of use, not price.

Our General Public Licenses are designed to make sure that you have the freedom to distribute copies of free software (and charge for this service if you wish) ; that you receive source code or can get it if you want it ; that you can change the software and use pieces of it in new free programs ; and that you are informed that you can do these things.

To protect your rights, we need to make restrictions that forbid distributors to deny you these rights or to ask you to surrender these rights. These restrictions translate to certain responsibilities for you if you distribute copies of the library or if you modify it.

For example, if you distribute copies of the library, whether gratis or for a fee, you must give the recipients all the rights that we gave you. You must make sure that they, too, receive or can get the source code. If you link other code with the library, you must provide complete object files to the recipients, so that they can relink them with the library after making changes to the library and recompiling it. And you must show them these terms so they know their rights.

We protect your rights with a two-step method : (1)we copyright the library, and (2)we offer you this license, which gives you legal permission to copy, distribute and/or modify the library.

To protect each distributor, we want to make it very clear that there is no warranty for the free library. Also, if the library is modified by someone else and passed on, the recipients should know that what they have is not the original version,so that the original author's reputation will not be affected by problems that might be introduced by others.

Finally, software patents pose a constant threat to the existence of any free program.

We wish to make sure that a company cannot effectively restrict the users of a free program by obtaining a restrictive license from a patent holder.

Therefore, we insist that any patent license obtained for a version of the library must be consistent with the full freedom of use specified in this license.

Most GNU software, including some libraries, is covered by the ordinary GNU General Public License. This license, the GNU Lesser General Public License, applies to certain designated libraries, and is quite different from the ordinary General Public License. We use this license for certain libraries in order to permit linking those libraries into non-free programs.

When a program is linked with a library, whether statically or using a shared library, the combination of the two is legally speaking a combined work, a derivative of the original library. The ordinary General Public License therefore permits such linking only if the entire combination fits its criteria of freedom.

The Lesser General Public License permits more lax criteria for linking other code with the library.

We call this license the "Lesser" General Public License because it does Less to protect the user's freedom than the ordinary General Public License. It also provides other free software developers Less of an advantage over competing non-free programs.

These disadvantages are the reason we use the ordinary General Public License for many libraries. However, the Lesser license provides advantages in certain special circumstances.

For example, on rare occasions, there may be a special need to encourage the widest possible use of a certain library, so that it becomes a de-facto standard. To achieve this, non-free programs must be allowed to use the library. A more frequent case is that a free library does the same job as widely used non-free libraries. In this case, there is little to gain by limiting the free library to free software only, so we use the Lesser General Public License.

In other cases, permission to use a particular library in non-free programs enables a greater number of people to use a large body of free software. For example, permission to use the GNU C Library in non-free programs enables many more people to use the whole GNU operating system, as well as its variant, the GNU/Linux operating system.

Although the Lesser General Public License is Less protective of the users' freedom, it does ensure that the user of a program that is linked with the Library has the freedom and the wherewithal to run that program using a modified version of the Library.

The precise terms and conditions for copying, distribution and modification follow. Pay close attention to the difference between a "work based on the library" and a "work that uses the library". The former contains code derived from the library, whereas the latter must be combined with the library in order to run.

## TERMS AND CONDITIONS FOR COPYING, DISTRIBUTION AND MODIFICATION

0. This License Agreement applies to any software library or other program which contains a notice placed by the copyright holder or other authorized party saying it may be distributed under the terms of this Lesser General Public License (also called "this License"). Each licensee is addressed as "you".

A "library" means a collection of software functions and/or data prepared so as to be conveniently linked with application programs (which use some of those functions and data) to form executables.

The "Library", below, refers to any such software library or work which has been distributed under these terms. A "work based on the Library" means either the Library or any derivative work under copyright law : that is to say, a work containing the Library or a portion of it, either verbatim or with modifications and/or translated straightforwardly into another language. (Hereinafter, translation is included without limitation in the term "modification".)

"Source code" for a work means the preferred form of the work for making modifications to it.

For a library, complete source code means all the source code for all modules it contains, plus any associated interface definition files, plus the scripts used to control compilation and installation of the library.

Activities other than copying, distribution and modification are not covered by this License ; they are outside its scope. The act of running a program using the Library is not restricted, and output from such a program is covered only if its contents constitute a work based on the Library (independent of the use of the Library in a tool for writing it).

Whether that is true depends on what the Library does and what the program that uses the Library does.

1. You may copy and distribute verbatim copies of the Library's complete source code as you receive it, in any medium, provided that you conspicuously and appropriately publish on each copy an appropriate copyright notice and disclaimer of warranty ; keep intact all the notices that refer to this License and to the absence of any warranty ; and distribute a copy of this License along with the Library.

You may charge a fee for the physical act of transferring a copy, and you may at your option offer warranty protection in exchange for a fee.

2. You may modify your copy or copies of the Library or any portion of it, thus forming a work based on the Library, and copy and distribute such modifications or work under the terms of Section 1 above, provided that you also meet all of these conditions :

- a)The modified work must itself be a software library.
- b)You must cause the files modified to carry prominent notices stating that you changed the files and the date of any change.
- c)You must cause the whole of the work to be licensed at no charge to all third parties under the terms of this License.
- d)If a facility in the modified Library refers to a function or a table of data to be supplied by an application program that uses the facility, other than as an argument passed when the facility is invoked, then you must make a good faith effort to ensure that, in the event an application does not supply such function or table, the facility still operates, and performs whatever part of its purpose remains meaningful.

(For example, a function in a library to compute square roots has a purpose that is entirely well-defined independent of the application. Therefore, Subsection 2d requires that any application-supplied function or table used by this function must be optional : if the application does not supply it, the square root function must still compute square roots.)

These requirements apply to the modified work as a whole. If identifiable sections of that work are not derived from the Library, and can be reasonably considered independent and separate works in themselves, then this License, and its terms, do not apply to those sections when you distribute them as separate works. But when you distribute the same sections as part of a whole which is a work based on the Library, the distribution of the whole must be on the terms of this License, whose permissions for other licensees extend to the entire whole, and thus to each and every part regardless of who wrote it. Thus, it is not the intent of this section to claim rights or contest your rights to work written entirely by you ; rather, the intent is to exercise the right to control the distribution of derivative or collective works based on the Library.

In addition, mere aggregation of another work not based on the Library with the Library (or with a work based on the Library) on a volume of a storage or distribution medium does not bring the other work under the scope of this License.

3. You may opt to apply the terms of the ordinary GNU General Public License instead of this License to a given copy of the Library. To do this, you must alter all the notices that refer to this License, so that they refer to the ordinary GNU General Public License, version 2, instead of to this License. (If a newer version than version 2 of the ordinary GNU General Public License has appeared, then you can specify that version instead if you wish.) Do not make any other change in these notices.

Once this change is made in a given copy, it is irreversible for that copy, so the ordinary GNU General Public License applies to all subsequent copies and derivative works made from that copy.

This option is useful when you wish to copy part of the code of the Library into a program that is not a library.

4. You may copy and distribute the Library (or a portion or derivative of it, under Section 2) in object code or executable form under the terms of Sections 1 and 2 above provided that you accompany it with the complete corresponding machine-readable source code, which must be distributed under the terms of Sections 1 and 2 above on a medium customarily used for software interchange.

If distribution of object code is made by offering access to copy from a designated place, then offering equivalent access to copy the source code from the same place satisfies the requirement to distribute the source code, even though third parties are not compelled to copy the source along with the object code.

5. A program that contains no derivative of any portion of the Library, but is designed to work with the Library by being compiled or linked with it, is called a "work that uses the Library". Such a work, in isolation, is not a derivative work of the Library, and therefore falls outside the scope of this License.

However, linking a "work that uses the Library" with the Library creates an executable that is a derivative of the Library (because it contains portions of the Library), rather than a "work that uses the library". The executable is therefore covered by this License.

Section 6 states terms for distribution of such executables.

When a "work that uses the Library" uses material from a header file that is part of the

Library, the object code for the work may be a derivative work of the Library even though the source code is not. Whether this is true is especially significant if the work can be linked without the Library, or if the work is itself a library.

The threshold for this to be true is not precisely defined by law.

If such an object file uses only numerical parameters, data structure layouts and accessors, and small macros and small inline functions (ten lines or less in length), then the use of the object file is unrestricted, regardless of whether it is legally a derivative work. (Executables containing this object code plus portions of the Library will still fall under Section 6.) Otherwise, if the work is a derivative of the Library, you may distribute the object code for the work under the terms of Section.

Any executables containing that work also fall under Section 6, whether or not they are linked directly with the Library itself.

6. As an exception to the Sections above, you may also combine or link a "work that uses the Library" with the Library to produce a work containing portions of the Library, and distribute that work under terms of your choice, provided that the terms permit modification of the work for the customer's own use and reverse engineering for debugging such modifications.

You must give prominent notice with each copy of the work that the Library is used in it and that the Library and its use are covered by this License. You must supply a copy of this License. If the work during execution displays copyright notices, you must include the copyright notice for the Library among them, as well as a reference directing the user to the copy of this License. Also, you must do one of these things :

- a) Accompany the work with the complete corresponding machine-

readable source code for the Library including whatever changes were used in the work (which must be distributed under Sections 1 and 2 above) ; and, if the work is an executable linked with the Library, with the complete machine-readable "work that uses the Library", as object code and/or source code, so that the user can modify the Library and then relink to produce a modified executable containing the modified Library. (It is understood that the user who changes the contents of definitions files in the Library will not necessarily be able to recompile the application to use the modified definitions.)

- b) Use a suitable shared library mechanism for linking with the Library. A suitable mechanism is one that (1) uses at run time a copy of the library already present on the user's computer system, rather than copying library functions into the executable, and (2) will operate properly with a modified version of the library, if the user installs one, as long as the modified version is interface-compatible with the version that the work was made with.
- c) Accompany the work with a written offer, valid for at least three years, to give the same user the materials specified in Subsection 6a, above, for a charge no more than the cost of performing this distribution.
- d) If distribution of the work is made by offering access to copy from a designated place, offer equivalent access to copy the above specified materials from the same place.
- e) Verify that the user has already received a copy of these materials or that you have already sent this user a copy.

For an executable, the required form of the "work that uses the Library" must include any data and utility programs needed for reproducing the executable

from it. However, as a special exception, the materials to be distributed need not include anything that is normally distributed (in either source or binary form) with the major components (compiler, kernel, and so on) of the operating system on which the executable runs, unless that component itself accompanies the executable. It may happen that this requirement contradicts the license restrictions of other proprietary libraries that do not normally accompany the operating system. Such a contradiction means you cannot use both them and the Library together in an executable that you distribute.

7. You may place library facilities that are a work based on the Library side-by-side in a single library together with other library facilities not covered by this License, and distribute such a combined library, provided that the separate distribution of the work based on the Library and of the other library facilities is otherwise permitted, and provided that you do these two things :
  - a) Accompany the combined library with a copy of the same work based on the Library, uncombined with any other library facilities. This must be distributed under the terms of the Sections above.
  - b) Give prominent notice with the combined library of the fact that part of it is a work based on the Library, and explaining where to find the accompanying uncombined form of the same work.
8. You may not copy, modify, sublicense, link with, or distribute the Library except as expressly provided under this License. Any attempt otherwise to copy, modify, sublicense, link with, or distribute the Library is void, and will automatically terminate your rights under this License. However, parties who have received copies, or rights, from you under this License will not have their licenses terminated so long as such parties remain in full compliance.



9. You are not required to accept this License, since you have not signed it. However, nothing else grants you permission to modify or distribute the Library or its derivative works. These actions are prohibited by law if you do not accept this License. Therefore, by modifying or distributing the Library (or any work based on the Library), you indicate your acceptance of this License to do so, and all its terms and conditions for copying, distributing or modifying the Library or works based on it.
10. Each time you redistribute the Library (or any work based on the Library), the recipient automatically receives a license from the original licensor to copy, distribute, link with or modify the Library subject to these terms and conditions. You may not impose any further restrictions on the recipients' exercise of the rights granted herein. You are not responsible for enforcing compliance by third parties with this License.
11. If, as a consequence of a court judgment or allegation of patent infringement or for any other reason (not limited to patent issues), conditions are imposed on you (whether by court order, agreement or otherwise) that contradict the conditions of this License, they do not excuse you from the conditions of this License. If you cannot distribute so as to satisfy simultaneously your obligations under this License and any other pertinent obligations, then as a consequence you may not distribute the Library at all. For example, if a patent license would not permit royalty-free redistribution of the Library by all those who receive copies directly or indirectly through you, then the only way you could satisfy both it and this License would be to refrain entirely from distribution of the Library.

If any portion of this section is held invalid or unenforceable under any particular circumstance, the balance of the section

is intended to apply, and the section as a whole is intended to apply in other circumstances.

It is not the purpose of this section to induce you to infringe any patents or other property right claims or to contest validity of any such claims; this section has the sole purpose of protecting the integrity of the free software distribution system which is implemented by public license practices.

Many people have made generous contributions to the wide range of software distributed through that system in reliance on consistent application of that system; it is up to the author/donor to decide if he or she is willing to distribute software through any other system and a licensee cannot impose that choice.

This section is intended to make thoroughly clear what is believed to be a consequence of the rest of this License.

12. If the distribution and/or use of the Library is restricted in certain countries either by patents or by copyrighted interfaces, the original copyright holder who places the Library under this License may add an explicit geographical distribution limitation excluding those countries, so that distribution is permitted only in or among countries not thus excluded. In such case, this License incorporates the limitation as if written in the body of this License.

13. The Free Software Foundation may publish revised and/or new versions of the Lesser General Public License from time to time. Such new versions will be similar in spirit to the present version, but may differ in detail to address new problems or concerns.

Each version is given a distinguishing version number. If the Library specifies a version number of this License which applies to it and "any later version", you have the option of following the terms and

conditions either of that version or of any later version published by the Free Software Foundation. If the Library does not specify a license version number, you may choose any version ever published by the Free Software Foundation.

14.If you wish to incorporate parts of the Library into other free programs whose distribution conditions are incompatible with these, write to the author to ask for permission. For software which is copyrighted by the Free Software Foundation, write to the Free Software Foundation ; we sometimes make exceptions for this. Our decision will be guided by the two goals of preserving the free status of all derivatives of our free software and of promoting the sharing and reuse of software generally.

## **NO WARRANTY**

15.BECAUSE THE LIBRARY IS LICENSED FREE OF CHARGE, THERE IS NO WARRANTY FOR THE LIBRARY, TO THE EXTENT PERMITTED BY APPLICABLE LAW. EXCEPT WHEN OTHERWISE STATED IN WRITING THE COPYRIGHT HOLDERS AND/OR OTHER PARTIES PROVIDE THE LIBRARY "ASIS" WITHOUT WARRANTY OF ANYKIND, EITHER EXPRESSED OR IMPLIED, INCLUDING, BUT NOT LIMITED TO, THE IMPLIED WARRANTIES OF MERCHANTABILITY AND FITNESS FOR A PARTICULAR PURPOSE.THE ENTIRE RISK AS TO THE QUALITY AND PERFORMANCE OF THE LIBRARY IS WITH YOU. SHOULD THE LIBRARY PROVE DEFECTIVE, YOU ASSUME THE COST OF ALL NECESSARY SERVICING, REPAIR OR CORRECTION.

16.IN NO EVENT UNLESS REQUIRED BY APPLICABLE LAW OR AGREED TO IN WRITING WILL ANY COPYRIGHT HOLDER, OR ANY OTHER PARTY WHO MAY MODIFY AND/OR REDISTRIBUTE THE LIBRARY AS PERMITTED ABOVE, BE LIABLE TO

YOU FOR DAMAGES, INCLUDING ANY GENERAL, SPECIAL, INCIDENTAL OR CONSEQUENTIAL DAMAGES ARISING OUT OF THE USE OR INABILITY TO USE THE LIBRARY (INCLUDING BUT NOT LIMITED TO LOSS OF DATA OR DATA BEING RENDERED INACCURATE OR LOSSES SUSTAINED BY YOU OR THIRD PARTIES OR A FAILURE OF THE LIBRARY TO OPERATE WITH ANY OTHER SOFTWARE), EVEN IF SUCH HOLDER OR OTHER PARTY HAS BEEN ADVISED OF THE POSSIBILITY OF SUCH DAMAGES.

## **END OF TERMS AND CONDITIONS**

### **How to Apply These Terms to Your New Libraries**

If you develop a new library, and you want it to be of the greatest possible use to the public, we recommend making it free software that everyone can redistribute and change. You can do so by permitting redistribution under these terms (or, alternatively, under the terms of the ordinary General Public License).

To apply these terms, attach the following notices to the library. It is safest to attach them to the start of each source file to most effectively convey the exclusion of warranty ; and each file should have at least the "copyright" line and a pointer to where the full notice is found.

One line to give the library's name and an idea of what it does.

Copyright (C)year name of author

This library is free software ; you can redistribute it and/or modify it under the terms of the GNU Lesser General Public License as published by the Free Software Foundation ; either version 2.1 of the License, or (at your option)any later version.

This library is distributed in the hope that it will be useful, but WITHOUT ANY

WARRANTY ; without even the implied warranty of MERCHANTABILITY or FITNESS FOR A PARTICULAR PURPOSE. See the GNU Lesser General Public License for more details.

You should have received a copy of the GNU Lesser General Public License along with this library ; if not, write to the Free Software Foundation, Inc., 51 Franklin Street, Fifth Floor, Boston, MA 02110-1301 USA

Also add information on how to contact you by electronic and paper mail.

You should also get your employer (if you work as a programmer) or your school, if any, to sign a "copyright disclaimer" for the library, if necessary. Here is a sample ; alter the names:

Yoyodyne, Inc., hereby disclaims all copyright interest in the library 'Frob' (a library for tweaking knobs) written by James Random Hacker.

signature of Ty Coon, 1 April 1990

Ty Coon, President of Vice

## OpenSSL LICENSE

Copyright (c) 1998-2006 The OpenSSL Project. All rights reserved.

Redistribution and use in source and binary forms, with or without modification, are permitted provided that the following conditions are met :

1. Redistributions of source code must retain the above copyright notice, this list of conditions and the following disclaimer.
2. Redistributions in binary form must reproduce the above copyright notice, this list of conditions and the following disclaimer in the documentation and/or other materials provided with the distribution.
3. All advertising materials mentioning features or use of this software must

display the following acknowledgment : "This product includes software developed by the OpenSSL Project for use in the OpenSSL Toolkit. (<http://www.openssl.org/>)"

4. The names "OpenSSL Toolkit" and "OpenSSL Project" must not be used to endorse or promote products derived from this software without prior written permission. For written permission, please contact [openssl-core@openssl.org](mailto:openssl-core@openssl.org).
5. Products derived from this software may not be called "OpenSSL" nor may "OpenSSL" appear in their names without prior written permission of the OpenSSL Project.
6. Redistributions of any form whatsoever must retain the following acknowledgment: "This product includes software developed by the OpenSSL Project for use in the OpenSSL Toolkit (<http://www.openssl.org/>)"

THIS SOFTWARE IS PROVIDED BY THE OpenSSL PROJECT "AS IS" AND ANY EXPRESSED OR IMPLIED WARRANTIES, INCLUDING, BUT NOT LIMITED TO, THE IMPLIED WARRANTIES OF MERCHANTABILITY AND FITNESS FOR A PARTICULAR PURPOSE ARE DISCLAIMED. IN NO EVENT SHALL THE OpenSSL PROJECT OR ITS CONTRIBUTORS BE LIABLE FOR ANY DIRECT, INDIRECT, INCIDENTAL, SPECIAL, EXEMPLARY, OR CONSEQUENTIAL DAMAGES (INCLUDING, BUT NOT LIMITED TO, PROCUREMENT OF SUBSTITUTE GOODS OR SERVICES ; LOSS OF USE, DATA, OR PROFITS ; OR BUSINESS INTERRUPTION) HOWEVER CAUSED AND ON ANY THEORY OF LIABILITY, WHETHER IN CONTRACT, STRICT LIABILITY, OR TORT (INCLUDING NEGLIGENCE OR OTHERWISE) ARISING IN ANY WAY OUT OF THE USE OF THIS SOFTWARE, EVEN IF ADVISED OF THE POSSIBILITY OF SUCH DAMAGE.

This product includes cryptographic software written by Eric Young (eay@cryptsoft.com).

This product includes software written by Tim Hudson (tjh@cryptsoft.com).

## Original SSLeay License

Copyright (C)1995-1998 Eric Young (eay@cryptsoft.com) All rights reserved. This package is an SSL implementation written by Eric Young (eay@cryptsoft.com). The implementation was written so as to conform with Netscapes SSL.

This library is free for commercial and noncommercial use as long as the following conditions are adhered to. The following conditions apply to all code found in this distribution, be it the RC4, RSA, lhash, DES, etc., code ; not just the SSL code.

The SSL documentation included with this distribution is covered by the same copyright terms except that the holder is Tim Hudson (tjh@cryptsoft.com).

Copyright remains Eric Young's, and as such any Copyright notices in the code are not to be removed.

If this package is used in a product, Eric Young should be given attribution as the author of the parts of the library used.

This can be in the form of a textual message at program startup or in documentation (online or textual) provided with the package.

Redistribution and use in source and binary forms, with or without modification, are permitted provided that the following conditions are met :

1. Redistributions of source code must retain the copyright notice, this list of conditions and the following disclaimer.
2. Redistributions in binary form must reproduce the above copyright notice, this list of conditions and the following disclaimer in the documentation

and/or other materials provided with the distribution.

3. All advertising materials mentioning features or use of this software must display the following acknowledgement :  
"This product includes cryptographic software written by Eric Young (eay@cryptsoft.com)" The word 'cryptographic' can be left out if the routines from the library being used are not cryptographic related :-).
4. If you include any Windows specific code (or a derivative thereof) from the apps directory (application code) you must include an acknowledgement :  
"This product includes software written by Tim Hudson (tjh@cryptsoft.com)"

THIS SOFTWARE IS PROVIDED BY ERIC YOUNG "AS IS" AND ANY EXPRESS OR IMPLIED WARRANTIES, INCLUDING, BUT NOT LIMITED TO, THE IMPLIED WARRANTIES OF MERCHANTABILITY AND FITNESS FOR A PARTICULAR PURPOSE ARE DISCLAIMED. IN NO EVENT SHALL THE AUTHOR OR CONTRIBUTORS BE LIABLE FOR ANY DIRECT, INDIRECT, INCIDENTAL, SPECIAL, EXEMPLARY, OR CONSEQUENTIAL DAMAGES (INCLUDING, BUT NOT LIMITED TO, PROCUREMENT OF SUBSTITUTE GOODS OR SERVICES ; LOSS OF USE, DATA, OR PROFITS ; OR BUSINESS INTERRUPTION) HOWEVER CAUSED AND ON ANY THEORY OF LIABILITY, WHETHER IN CONTRACT, STRICT LIABILITY, OR TORT (INCLUDING NEGLIGENCE OR OTHERWISE) ARISING IN ANY WAY OUT OF THE USE OF THIS SOFTWARE, EVEN IF ADVISED OF THE POSSIBILITY OF SUCH DAMAGE.

The licence and distribution terms for any publicly available version or derivative of this code cannot be changed. i.e. this code cannot simply be copied and put under another distribution licence [including the GNU Public Licence.]



### **Correct Disposal of This Product** (Waste Electrical & Electronic Equipment)

---

(Applicable in the European Union and other European countries with separate collection systems)

This marking on the product, accessories or literature indicates that the product and its electronic accessories (e.g. charger, headset, USB cable) should not be disposed of with other household waste at the end of their working life. To prevent possible harm to the environment or human health from uncontrolled waste disposal, please separate these items from other types of waste and recycle them responsibly to promote the sustainable reuse of material resources.

Household users should contact either the retailer where they purchased this product, or their local government office, for details of where and how they can take these items for environmentally safe recycling.

Business users should contact their supplier and check the terms and conditions of the purchase contract. This product and its electronic accessories should not be mixed with other commercial wastes for disposal.